

Spectrophotometer CM-5

Instruction Manual



Please read before
using the instrument.



KONICA MINOLTA

Safety Symbols

The following symbols are used in this manual to prevent accidents which may occur as a result of incorrect use of the instrument.



Denotes an instruction regarding a safety warning or note.
Read the instruction carefully to ensure safe and correct use.



Denotes an instruction regarding the risk of electric shock.
Read the instruction carefully to ensure safe and correct use.



Denotes an instruction regarding the risk of fire.
Read the instruction carefully to ensure safe and correct use.



Denotes a prohibited operation.
This operation must never be performed.



Denotes an instruction.
This instruction must be strictly adhered to.



Denotes a prohibited operation.
Never disassemble the instrument.



Denotes an instruction.
Be sure to disconnect the AC adapter from the AC outlet.



This symbol indicates A.C.



This symbol indicates D.C.



This symbol indicates class II protection against electric shock.

Trademarks











- Windows® is a registered trademark of Microsoft Corporation in the United States and other countries.







Notes on this Manual

- Copying or reproduction of all or part of the contents of this manual without the permission of KONICA MINOLTA is strictly prohibited.
- The contents of this manual are subject to change without prior notice.
- Every effort has been made in the preparation of this manual to ensure the accuracy of its contents.
- However, should you have any questions or find any errors, please contact your retailer or a KONICA MINOLTA-authorized service facility.
- KONICA MINOLTA will not accept any responsibility for consequences arising from the use of the instrument.

Safety Precautions

To ensure correct use of this instrument, read the following points carefully and adhere to them.
After you have read this manual, keep it in a safe place where it can be referred to anytime a question arises.

 WARNING (Failure to adhere to the following points may result in death or serious injury.)	
 <p>Do not use the instrument in places where flammable or combustible gases (gasoline etc.) are present. Doing so may cause a fire.</p>	 <p>Do not disassemble or modify the instrument or the AC adapter. Doing so may cause a fire or electric shock.</p>
 <p>Always use the AC adapter supplied as a standard accessory or the optional AC adapter, and connect it to an AC outlet of the rated voltage and frequency. If an AC adapter other than those specified by KONICA MINOLTA is used, it may result in damage to the unit, fire or electric shock.</p>	 <p>Take special care not to allow liquid or metal objects to enter the instrument and the AC adapter. Doing so may cause a fire or electric shock. Should liquid or metal objects enter the instrument, turn the power OFF immediately, disconnect the AC adapter plug from the AC outlet, and contact the nearest KONICA MINOLTA-authorized service facility.</p>
 <p>If the instrument will not be used for a long time, disconnect the AC adapter plug from the AC outlet. Accumulated dirt or water on the prongs of the AC adapter's plug may cause a fire and should be removed.</p>	 <p>The instrument should not be operated if it is damaged or the AC adapter is damaged, or if smoke or odd smells occur. Doing so may cause a fire. In such situations, turn the power OFF immediately, disconnect the AC adapter plug from the AC outlet and contact the nearest KONICA MINOLTA-authorized service facility.</p>
 <p>Do not forcibly bend, twist, or pull the AC adapter power cable. Do not scratch or alter the power cable or place heavy objects on it. Doing so may damage the power cable and cause a fire or electric shock.</p>	 <p>Always hold the plug itself when disconnecting the AC adapter plug from the AC outlet. Pulling on the power cable may damage it and cause a fire or electric shock.</p>
 <p>Insert the power plug fully and securely. Incomplete insertion may cause fire or electric shock.</p>	 <p>Do not insert or disconnect the AC adapter plug from an AC outlet with wet hands. Doing so may cause electric shock.</p>

 CAUTION (Failing to adhere to the following points may result in injury or damage to the instrument or other property.)	
 <p>Do not perform measurement with the specimen measuring port directed towards your eyes. Doing so may damage your eyes.</p>	 <p>Do not place the instrument on an unstable or sloping surface. Doing so may result in its dropping or overturning, causing injury. Be careful not to drop the instrument when carrying it.</p>
 <p>Be careful not to get your hand caught in the openable section of the instrument. Doing so may result in injury.</p>	
 <p>When cleaning, unplug the power plug. Leaving it plugged in may cause electric shock.</p>	 <p>Make sure that the AC outlet is located near the instrument and that the AC adapter plug can be connected to and disconnected from the AC outlet easily.</p>

Introduction

Thank you for purchasing the CM-5.

This is a precise, benchtop type spectrophotometer developed for color and color difference measurement of reflective/transmitted objective colors in various industries.

Packing materials of the product

Be sure to keep all packing materials used for shipping the product (cardboard box, cushioning material, plastic bags, etc.).

The CM-5 is a precision measuring instrument. When transporting the instrument to a service facility for maintenance or for other reasons, be sure to use the packing materials to minimize shock or vibration.

If the packing materials are lost or damaged, contact a KONICA MINOLTA-authorized service facility.

Notes on Use

Be sure to use this instrument properly. Use of this instrument in ways other than those specified in this manual may result in risk of injury, electric shock, instrument damage, or other problems.

Operating Environment

- Use the CM-5 at an ambient temperature between 13°C and 33°C and relative humidity 80% or less (at 35°C) with no condensation.

Be sure to use the instrument within this range. Do not use it in areas of rapid temperature changes.

- Do not leave the CM-5 in direct sunlight or near sources of heat, such as stoves etc. The internal temperature of the instrument may become much higher than the ambient temperature in such cases.
- Do not use the CM-5 in areas where dust, cigarette smoke or chemical gases are present. Doing so may cause deterioration in performance or a breakdown.
- Do not use the CM-5 near equipment which produces a strong magnetic field (such as speakers etc.).
- The CM-5 belongs to installation category I products (equipment which is powered by an AC adapter connected to commercially available power).
- The CM-5 belongs to pollution level 2 products (equipment which may cause temporary electrical hazards due to contamination or condensation or products which are used in such an environment).
- Do not use the CM-5 at altitudes higher than 2,000 m.
- The CM-5 and the AC adapter supplied as a standard accessory have been designed exclusively for indoor use. They should never be used outdoors because rain or other factors may damage the instrument.

Measurement

- Make sure no dirt or dust get into the specimen measuring port.
- Use a blower to remove dust and dirt from the shutter before using the instrument after a long period of disuse.
- When using the instrument for long periods of time, the measurement value may change depending on changes in the environment. Therefore, in order to achieve accurate measurements, we recommend that white calibration be done regularly using the White Calibration Cap.

White Calibration Plate

There are two types of white calibration plate for use with this instrument: the built-in White Calibration Plate inside the shutter and an external White Calibration Plate as an optional accessory.

- The calibration data for the White Calibration Plate was measured at 23°C.
To achieve the highest accuracy when measuring absolute values (colorimetric values), calibration and measurement should be performed at 23°C.
- Do not allow the White Calibration Plate (optional accessory) to get scratched or stained, or get fingerprints on it.
- When the White Calibration Plate (optional accessory) is not in use, be sure to close the cap so that the White Calibration Plate is not exposed to ambient light.

Target Mask

There are three types of Target Masks for use with this instrument: the standard ø30 mm mask, and optional ø3 mm and ø8 mm masks.

- The ø30 mm Target Mask must be used in combination with the instrument that bears the same pairing number.
- Do not touch the Target Mask's inner surface by hand, scratch it or make it dirty.
- When not in use, Target Masks should be stored in the packing used for shipment or in the optional accessory case so that they will not be exposed to ambient light.

Power Source

- Make sure that the power switch is set to OFF (“O”) when the CM-5 is not in use.
- This instrument can be powered from the AC adapter (AC-A305).
- Always use the AC adapter supplied as a standard accessory (AC-A305) and connect it to an AC outlet of the rated voltage and frequency. Use an AC power supply of the rated supply voltage (within $\pm 10\%$).
- Do not connect the AC adapter to an overloaded electrical circuit. In addition, do not wrap or cover the AC adapter with cloth or other material while in use. Doing so may cause an electric shock or fire.

System

- Do not subject the CM-5 to strong impact or vibration. Doing so may cause deterioration in performance or a breakdown.
- Since the specimen measuring port and integrating sphere are extremely precise optical components, great care should be taken to prevent them getting dirty or exposing them to impact.
- The CM-5 may cause interference if used near a television, radio, etc.
- When the instrument is exposed to strong external static electricity, the LCD may go blank or the measurement result may not be displayed properly. If the instrument is communicating with an external device, the communication may be interrupted. In these cases, turn the power OFF and then turn it ON again. If black smudges appear on the LCD, wait until they disappear naturally.
- When turning the power OFF and then ON again, wait several seconds after turning the power OFF.

Backup Battery

- Measured data and various settings are stored in the memory backed up by batteries. The backup batteries are automatically charged during operation of this instrument, and can retain the contents of the memory for three months if they have been fully charged. At the time of purchase, the backup battery may not be fully charged. To charge the backup battery, set the power switch to ON. The backup battery is fully charged in 72 hours while the instrument is switched on, and there is no danger of overcharging.
- It is recommended to keep a backup of your important data on another recording medium using the optional Color Management Software SpectraMagic™ NX (CM-S100w).

Notes

- The backup batteries' model number is ML2020 (3 V).
- Do not try to replace the backup batteries by yourself. Contact a KONICA MINOLTA-authorized service facility.

Notes on Storage

- The CM-5 should be stored at temperatures between 0°C and 40°C, and at a relative humidity of 80% or less (35°C) without condensation. Do not store the instrument in areas subject to high temperatures, high humidity, sudden changes in temperature, or where freezing or condensation may occur, because these circumstances may cause a breakdown. It is recommended to store the CM-5 with a drying agent at a temperature around 20°C.
- Do not leave the CM-5 inside a car such as in the cabinet or trunk. Otherwise, the temperature and/or humidity may exceed the allowable range for storage during midsummer or midwinter, resulting in a breakdown.
- Keep the packing materials used for shipment and use them to transport the CM-5. This protects the instrument from sudden changes in temperature, vibration, and shock.
- Do not store the CM-5 in areas where dust, cigarette smoke or chemical gases are present. Doing so may cause deterioration in performance or a breakdown.
- Entry of dust into the specimen measuring port will hinder accurate measurement. When the instrument is not in use, you must close the transmittance specimen chamber and cover the instrument with the supplied Dust Cover to prevent the entry of dust into the integrating sphere.
- The White Calibration Plate (optional accessory) may become discolored if left exposed to light. Therefore, make sure to close the cap when it is not in use so that the White Calibration Plate is not exposed to ambient light during storage.
- The Target Masks may discolor if they are left exposed to light. When they are not in use, keep them in a safe place to prevent exposure to light and to protect them from scratches and dust.
- Be sure to keep all packing materials (cardboard box, cushioning material, plastic bags, etc.). They can be used to protect the instrument during transportation to the service facility for maintenance (re-calibration etc.).

Notes on Cleaning

- If the CM-5 becomes dirty, wipe it with a soft, clean dry cloth. Never use solvents such as thinner or benzene.
- If the White Calibration Plate (optional accessory) becomes dirty, wipe it with a soft, clean dry cloth. If dirt is difficult to remove, wipe it off with a cloth dampened with commercially-available lens cleaning solution. Then remove the solution with a cloth dampened with water, and leave the plate to dry.
- If the inner surface of the Target Masks, the inside of the integrating sphere, or the built-in White Calibration Plate get dirty, contact a KONICA MINOLTA-authorized service facility.
- Should the CM-5 break down, do not try to disassemble and repair it by yourself. Contact a KONICA MINOLTA-authorized service facility.

Disposal Method

- Make sure that the CM-5, its accessories, and the packing materials are either disposed of or recycled correctly in accordance with local laws and regulations.

Table of Contents

Safety Precautions	1
Introduction	2
Notes on Use.....	2
Notes on Storage.....	4
Notes on Cleaning.....	4
Disposal Method	4
Conventions	8

Chapter 1 - Before Using the Instrument

Accessories	10
Standard Accessories	10
Optional Accessories.....	11
System Diagram	14
Names and Functions of Parts	15
Cleaning Parts	17
Connecting the Functional Ground Cable	19
Connecting the AC Adapter	20
Turning power ON/OFF	20
Items You Must Know	21
Initial Settings of the CM-5.....	21
Control Panel.....	21
Data Saving	25

Chapter 2 - Preparation for Measurement

Flow of Measurement	28
Quick Setting Wizard	29
Setting a specimen	42
Reflectance measurement.....	42
Petri Dish/Mini Petri Dish measurements.....	43
Specimen Viewing Mirror (Optional).....	47
Transmittance Measurement and Liquid Measurement	48
Calibration	52
Zero Calibration (0% Calibration)	52
White Calibration (100% Calibration)	55
User Calibration	58
Condition Setting	59
Setting the Measurement Conditions.....	59
Measurement Option Settings.....	63
Setting the Display Conditions	67
Color Difference Target Color Data Operation	76
Settings	76
Editing Target Color Data	78
Other Settings	93
Setting Automatic White Calibration (100% Calibration) to ON/OFF	93
Setting the Measurement Result Display.....	95
Setting the Screen Options.....	101
Setting the Date and Time.....	105
Batch Setting of Conditions	108

Chapter 3 - Measurement

Measurement	112
Displaying the Measurement Results	113
<Sample> Detail Screen: Absolute	113
<Sample> Detail Screen: "Difference" Tab.....	114
<Sample> Detail Screen: "Abs. & Diff." Tab	114
<Sample> Detail Screen: "Custom" Tab	115
<Sample> Detail Screen: "Abs.Graph" Tab	115
<Sample> Detail Screen: "Diff.Graph" Tab	116
<Sample> Detail Screen: "Assess.Graph" Tab	117
<Sample> Detail Screen: "Spectral" Tab	118
<Sample> List Screen	119
Switching the Display Contents of the Measurement Results.....	120
Sample Data Operation	122
Saving the Current Sample Data to a USB Memory Device.....	123
Performing Statistical Calculations on Sample Data.....	125
Edit Name.....	126
Print	127
Delete.....	128
Sample=>Target.....	129
Saving Data onto a USB Memory Device	130
Auto Target.....	132
Delete All.....	133
Average Measurement	134
Manual Measurement.....	134
Auto Measurement	136

Chapter 4 - Other Functions

Pass/Fail Judgment for Color Difference	138
Pass/Fail Judgment Based on Tolerances.....	138
Connecting to an External Device	141
Connecting a USB Memory	141
Connecting a USB Keyboard.....	143
Connecting a Personal Computer.....	144
Printer Connection	145
System-related Functions	152
Displaying the Instrument Information	152
Annual Service Recalibration Recommendation Message	153
Initialization	155

Chapter 5 - Troubleshooting

Error Messages	160
Troubleshooting	163

Chapter 6 - Appendix

Principles of Measurement	166
Illuminating/Viewing System.....	166
Illumination Area and Measurement Area	167
Main Specifications	168
Dimensions	170

Conventions

This manual describes how to safely operate the CM-5 using a specific procedure to perform measurement.

• Page layout

Symbols used in this manual are explained below.

* Note that the page shown in the illustration is for explanatory purposes only, and is not an actual page from this manual.

Memo

Provides useful information, supplementary explanations, and similar details.

Notes

Provides information that you need to know in order to operate the CM-5 correctly. Always read this information before operating the CM-5.

Procedure

Indicates an operating procedure.

Settings

Describes ranges and provides explanations regarding settings for the screen in question.

Condition Setting

The CM-5 requires condition settings (measurement condition, measurement option, and color) before measurement can be started.

Memo To configure condition settings, select "Meas. Condition" (measurement conditions), "Meas. Option" (measurement options) or "Color" (display conditions) from the <Configuration> screen to open an appropriate screen.

Notes If any predefined condition is selected, the condition setting (measurement condition/measurement option/color) is disabled. Set the condition to OFF before starting condition setting.

Setting the Measurement Conditions

To set measurement conditions, select "Meas. Condition" from the <Configuration> screen. You can select or specify the following three items as the measurement conditions.

- Meas. Type: Select the measurement type such as reflectance measurement or transmittance measurement.
- Meas. Area: When the measurement type is reflectance measurement, select an measurement area.
- SCI/SCE: When the measurement type is reflectance measurement, select the specular component mode.

[Setting Procedure]

- Press the [Menu] button. The <Configuration> screen is displayed.
- Use the or button of the cross key to move the cursor to "Meas. Condition" and then press the [Enter]/[Edit] button. The <Measurement Condition Settings> screen is displayed.
 - The <Measurement Condition Settings> screen shows the current settings.
- After you set the measurement conditions, you can press the [BACK] button to return to the screen displayed before you press the [Menu] button in Step 1.

Memo To return to the <Configuration> screen, press the [Menu] button.



Start screen

Indicates the initial screen from which the operation is commenced.

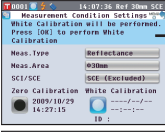

Screenshot

Indicates the state of the screen when the operation described in the procedure to the left is carried out.

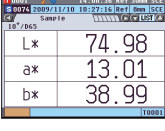

E50

For the version of the instrument firmware

The version of the instrument firmware can be confirmed on the <Information> screen. For details, refer to page 152 "Displaying the Instrument Information" in this manual.

Chapter 1

Before Using the Instrument

Accessories

Standard and optional accessories are available with the instrument.

Memo The shape of some products may be different from those shown.

Standard Accessories

Make sure that all the following items are present.

Target Mask: ø30 mm CM-A197

During reflectance measurement, this target mask can be replaced with the optional target mask (ø3 mm or ø8 mm) to change the illumination area (specimen measuring port size) according to the specimen.

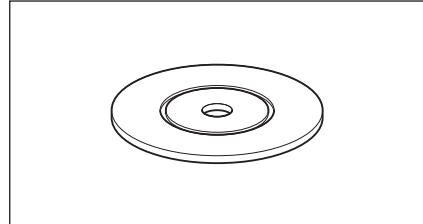

Transmittance Mask ø20 mm CM-A200

Attached to the instrument.
Guides light to the Transmittance Specimen Chamber when conducting transmittance measurement.

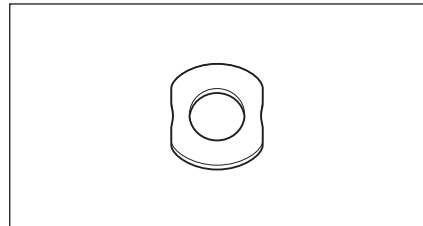

AC Adapter: AC-A305

Used to supply power from an AC outlet to the instrument.

Input: 100-240 V \sim 50/60 Hz 24-38 VA

Output: 5 V --- 2 A

Plug design: \oplus \ominus Center-negative

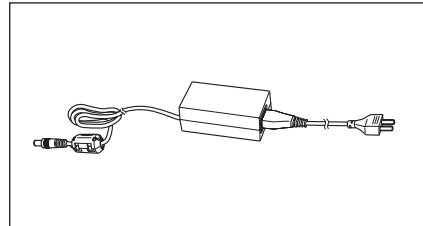

USB Cable (2 m): I F-A19

Used to connect the instrument to a personal computer (PC).

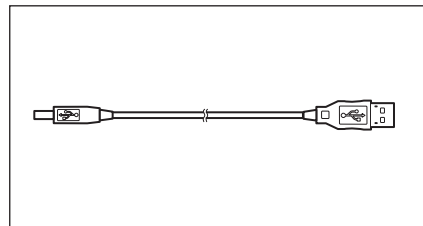

Functional Ground Cable: CM-A211

Used to prevent communication problems caused by static electricity when connected to a PC.

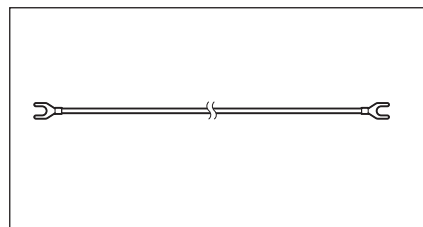





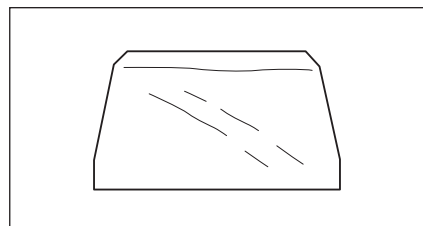



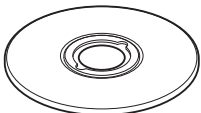

Dust Cover: CM-A191

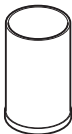
Used to protect the instrument by preventing dust from entering the inside.

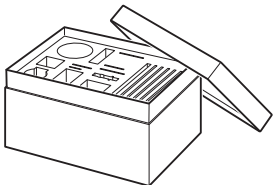

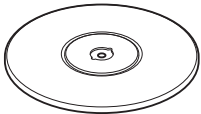

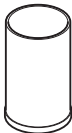
Optional Accessories

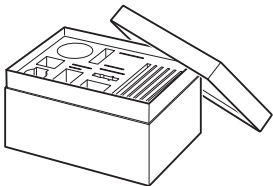
You may purchase the following accessories if necessary.

Petri Dish Measurement Full Set CM-A205		
<p>Petri Dish: CM-A128</p> 	<p>Target Mask (for Petri Dish): CM-A203 Used to perform reflectance measurement using a Petri Dish.</p> 	<p>Calibration Glass (for Petri Dish): CM-A212 Used for calibration for reflectance measurement using a Petri Dish.</p> 
<p>Zero Calibration Box: CM-A124</p> <p>Used to perform zero calibration.</p> 	<p>White Calibration Plate: CM-A210 (with CD-ROM containing calibration data and data-setting software) Can be used in place of the built-in White Calibration Plate to perform white calibration.</p> 	<p>Accessory Case: CM-A193</p> 
Mini Petri Dish Measurement Full Set CM-A164		
<p>Mini Petri Dish: CM-A157</p> 	<p>Target Mask (for Mini Petri Dish): CM-A158 Used to perform reflectance measurement using a Mini Petri Dish.</p> 	<p>Calibration Glass (for Mini Petri Dish): CM-A159 Used for calibration for reflectance measurement using a Mini Petri Dish.</p> 
<p>Zero Calibration Box: CM-A124</p> <p>Used to perform zero calibration.</p> 	<p>White Calibration Plate: CM-A210 (with CD-ROM containing calibration data and data-setting software) Can be used in place of the built-in White Calibration Plate to perform white calibration.</p> 	<p>Accessory Case: CM-A193</p> 

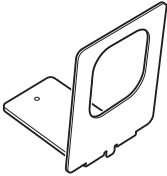
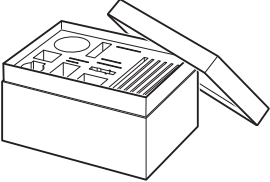
Notes Instructions and notes regarding the use of the Mini Petri Dish CM-A157 and its accessories are the same as for the Petri Dish CM-A128 unless otherwise specified.

Transmittance Measurement Set CM-A206		
<p>Transmittance Zero Calibration Plate: CM-A213 A light-shielding plate used for zero calibration for transmittance measurement.</p> 	<p>Transmittance Specimen Holder Attachment: CM-A199 Used to attach the transmittance specimen holder to the receiving window side.</p> 	<p>Accessory Case: CM-A193</p> 
<p>Transmittance Specimen Holder: CM-A96</p> 		

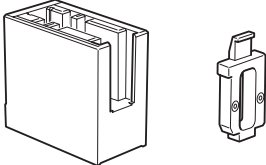
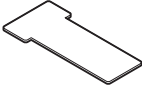
10 mm Wide Cell Measurement Set CM-A207	
<p>Transmittance Specimen Holder (10 mm wide): CM-A198</p> 	<p>Transmittance Zero Calibration Plate (10 mm): CM-A204</p> 

Set of accessories used to perform transmittance measurement of liquid specimen using a commercially available 10 mm-wide Cell.

Color Management Software SpectraMagic™ NX CM-S100w

Used to operate the instrument from a PC for data processing and file management.

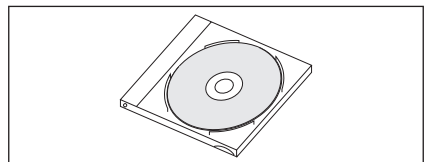

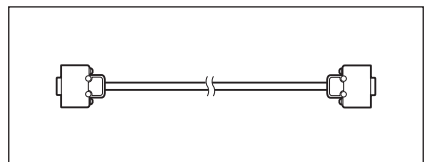

Connecting Cable: CM-A58

Used to connect the instrument to a commercially available serial data printer.

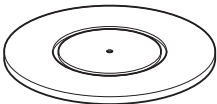
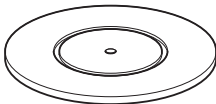



Target Mask	
Target Mask: ϕ3 mm CM-A195 	Target Mask: ϕ8 mm CM-A196 

Used to switch the illumination area (specimen measuring port size) according to the specimen.

Cell		
Cell: 2 mm CM-A97 	Cell: 10 mm CM-A98 	Cell: 20 mm CM-A99 

A glass container to contain the liquid specimen during transmittance measurement.

Plastic Cell		
Plastic Cell: 2 mm CM-A130 	Plastic Cell: 10 mm CM-A131 	Plastic Cell: 20 mm CM-A132 

A plastic container to contain the liquid specimen during transmittance measurement.

Specimen Viewing Mirror CM-A202

Used to check the measurement points on the specimen for reflectance measurement.

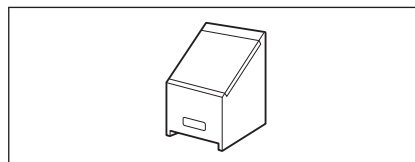

Color Tiles (14 colors)

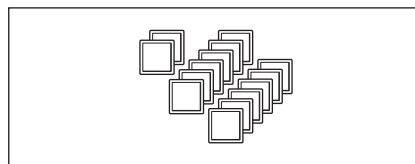

System Diagram

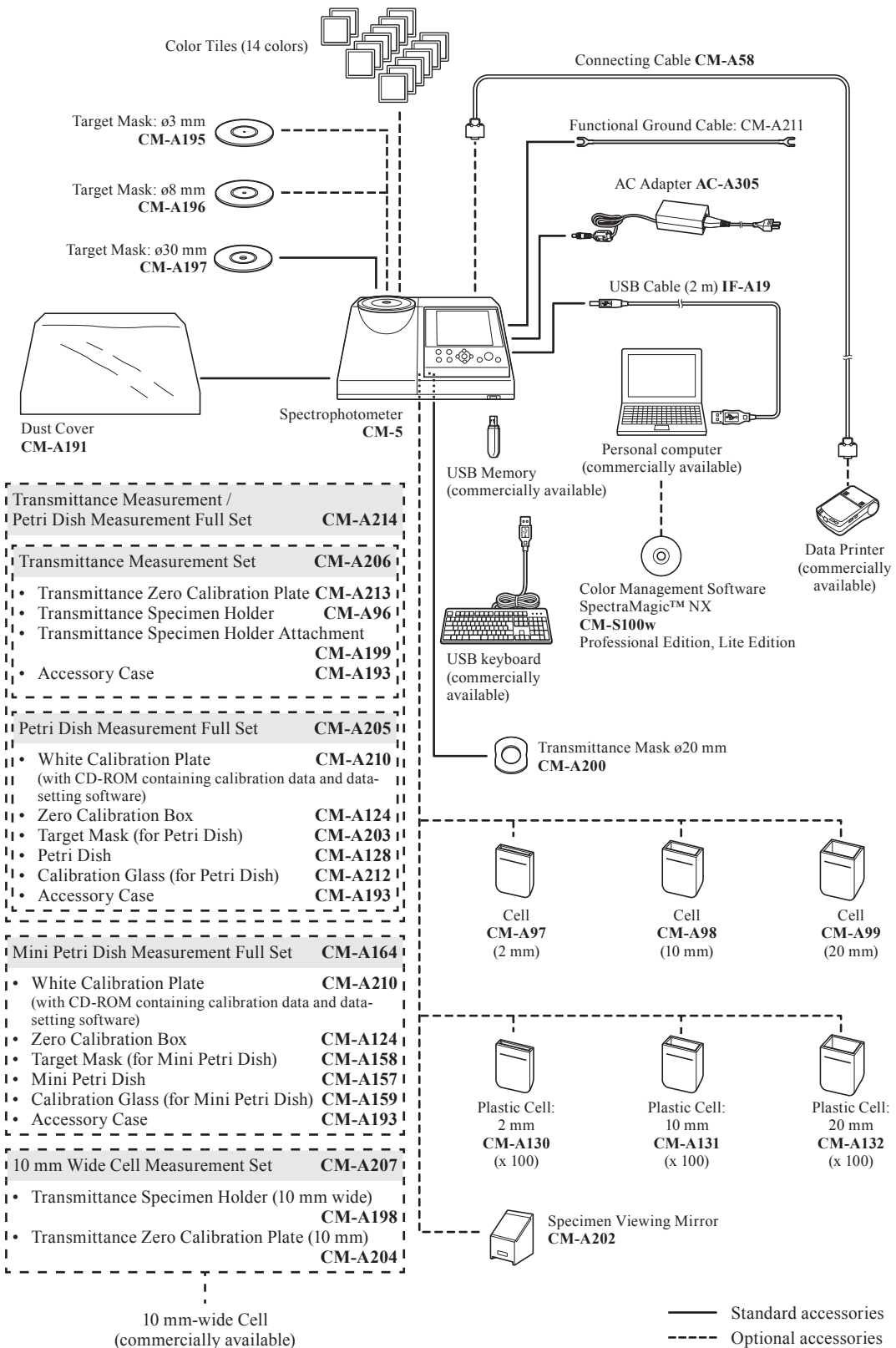

Names and Functions of Parts

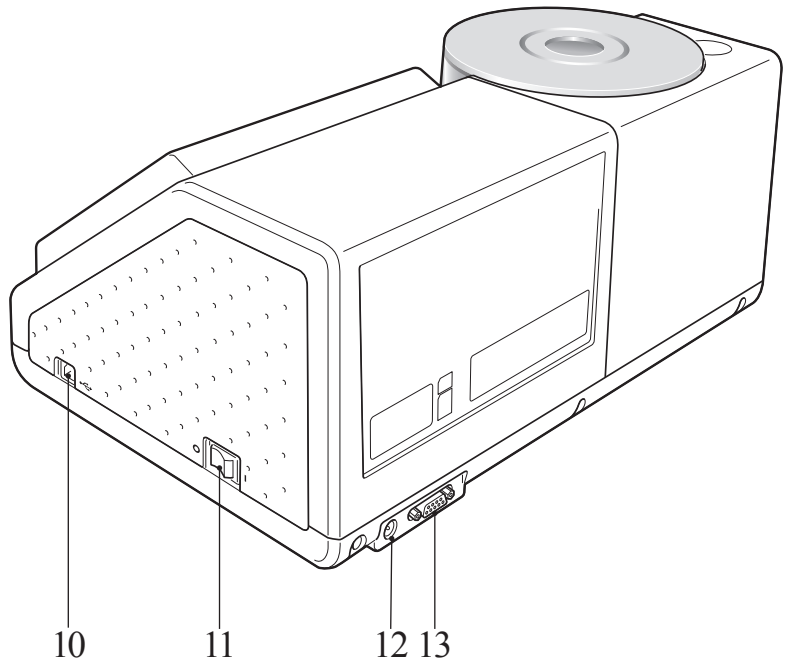
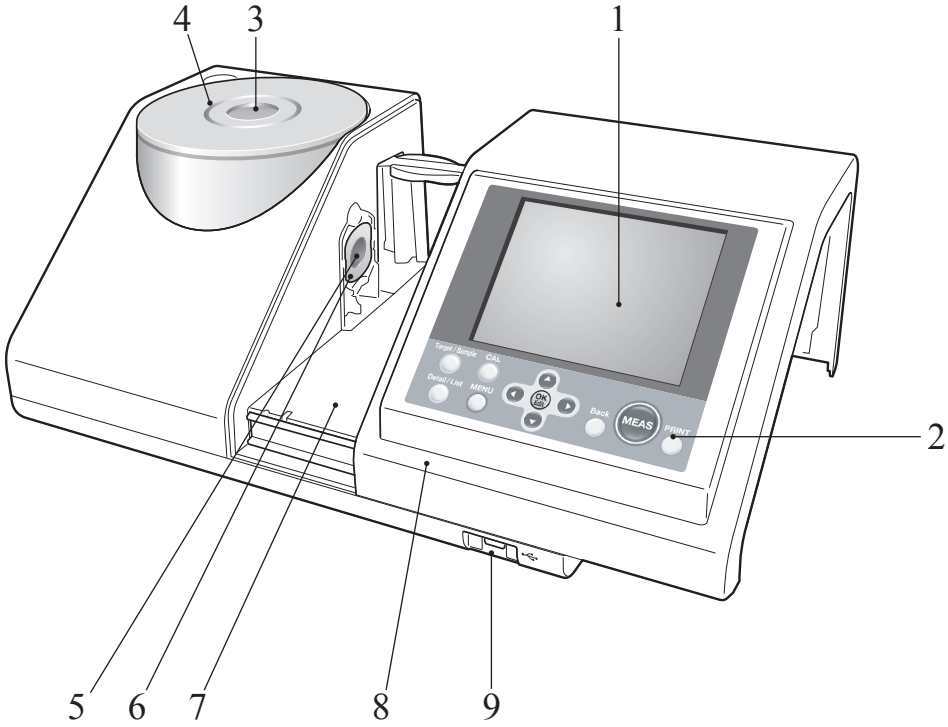

1	LCD screen	Displays setting items, measurement results and messages.
2	Control panel	Used to switch screens or select/determine/save setting items. For details, refer to page 23 “Control Buttons”.
3	Specimen measuring port	The port for measuring the specimen. The port size can be changed by changing the Target Masks. This port opens its shutter only for measurement. Inside the shutter is the built-in White Calibration Plate.
4	Target Mask	During reflectance measurement, this target mask can be replaced with the optional target mask $\varnothing 3$ mm (CM-A195) or $\varnothing 8$ mm (CM-A196) to change the illumination area (specimen measuring port size) according to the specimen.
5	Illumination window	The port for measuring the specimen.
6	Transmittance Mask	Guides light to the Transmittance Specimen Chamber when conducting transmittance measurement.
7	Transmittance Specimen Chamber	For transmittance measurement, set a specimen in this chamber.
8	Transmittance Specimen Chamber Cover	Slide this cover to open/close the Transmittance Specimen Chamber.
9	USB connection terminal (A type)	Used to attach a USB memory device to the instrument. When a USB memory device is properly connected to the instrument, the  (USB memory device connected) icon is displayed. A USB keyboard can also be used to input file names and sample data names. The screen display does not change when a USB keyboard is attached.
10	USB connection terminal (B type)	Used to connect the instrument to a PC with the supplied USB cable (IF-A19).
11	Power switch	Used to turn ON/OFF power. Setting this switch to “○” turns the power OFF, and setting it to “■” turns the power ON.
12	AC adapter terminal	When using the supplied AC adapter (CM-A305), connect the adapter’s plug to this terminal.
13	RS-232C Connector	Used to connect the instrument to the optional data printer with the optional connecting cable (CM-A58).

Cleaning Parts

This section explains how to clean the Target Mask, White Calibration Plate, Zero Calibration Box, and the inside of the integrating sphere.

Target Mask and Transmittance Mask (Standard/optional accessory)

Use a blower to remove dirt and dust from the Target Masks.

Notes Do not touch the inside (edge) of the Target Mask with your fingers. If it becomes dirty, wipe it with a soft, clean dry cloth.

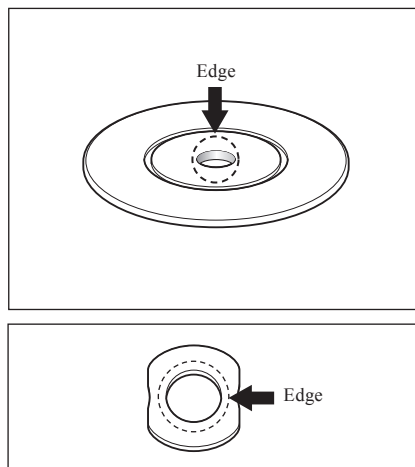

White Calibration Plate (Optional)

- When the White Calibration Plate becomes dirty, gently wipe the dirt off with a soft dry cloth. If the dirt is difficult to remove, wipe it off with a cloth dampened with commercially available lens cleaning solution. Then remove the solution with a cloth dampened with water, and leave the plate to dry.
- When parts other than the White Calibration Plate become dirty, lightly wipe the dirt off with a cloth dampened with water or soapy water. Never use solvents such as thinner or benzene.

Notes Be careful not to scratch the White Calibration Plate.

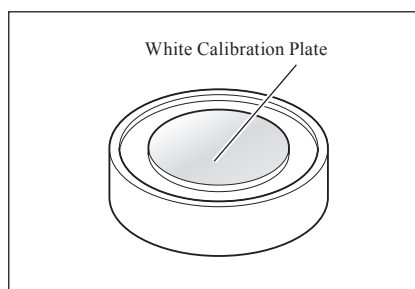

Zero Calibration Box (Optional)

Use a blower to remove dirt from the inside of the box.

If the inner surface is accidentally touched with hands or fingers, wipe off the fingerprints or other traces gently with a soft dry cloth.

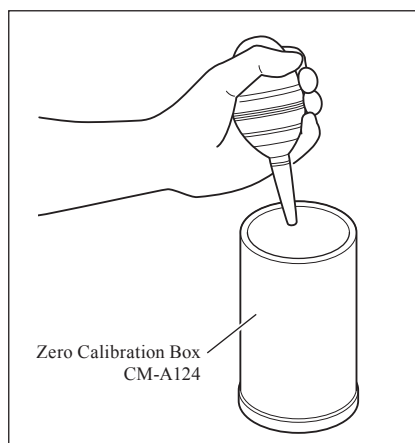

Inside the Integrating Sphere

1. Set specular component to SCE.

Memo For the procedure for switching the specular component, refer to “SCI/SCE” on page 62.

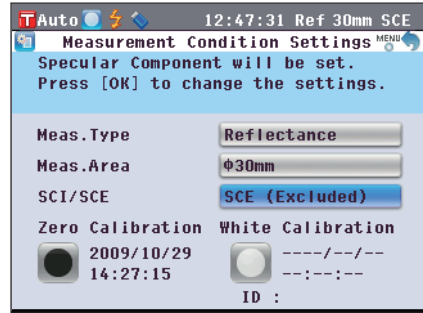

2. Ensure that there is nothing in the Transmittance Specimen Chamber.

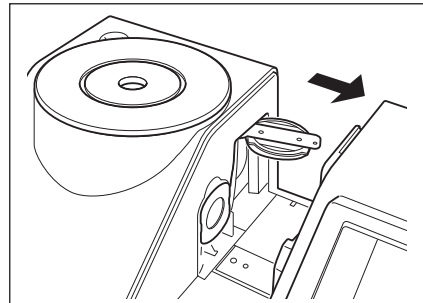

3. Block the receiving window of the Transmittance Specimen Chamber so that no dust or dirt enters through it.

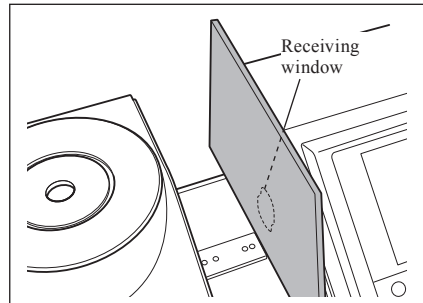

4. Open the shutter and blow off the dust and dirt in the Integrating Sphere with a blower.

Memo For the procedure for opening/closing the shutter, refer to page 66 “Shutter Open/Close”.

Notes Do not touch the white-coated inner surface of the integrating sphere, wipe it with a cloth or put an object inside it. If the inside is so dirty that dirt cannot be removed with a blower, contact the nearest KONICA MINOLTA-authorized service facility.

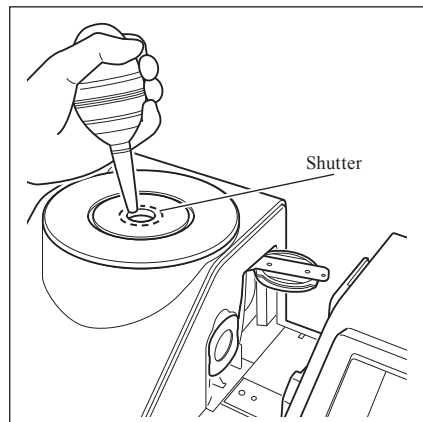

Receiving window of the Transmittance Specimen Chamber

1. Set measuring diameter to $\phi 3$ mm.

Memo For the procedure for switching measuring diameter, refer to page 61 “Measurement Area”.



2. Use a blower to remove dirt and dust from the receiving window.

Notes Do not insert your finger through the receiving window to touch the lens of the light-receiving optical system.

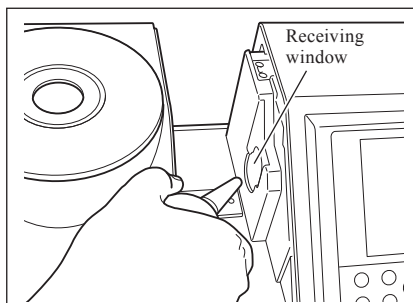

Connecting the Functional Ground Cable

Notes Attach the Functional Ground Cable (CM-A211) in order to avoid communication problems with the PC caused by static electricity.

[Procedure]

1. Connect the Y terminal of the Functional Ground Cable to the Connection Terminal Screw on the rear of the instrument.

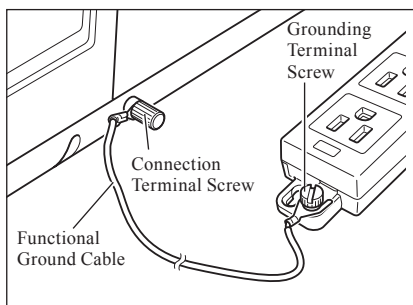

2. Connect the other Y terminal of the Functional Ground Cable to a reliably grounded object (e.g. a 100-240 VAC earth terminal or a metal desk).

Connecting the AC Adapter

- Notes**
- To supply AC power to the instrument, always use the AC adapter (AC-A305) supplied with the instrument.
 - Before connecting or disconnecting the AC adapter jack or plug, make sure that the instrument is turned OFF.

[Procedure]

1. Make sure that power is OFF (Power switch is set to “○”).

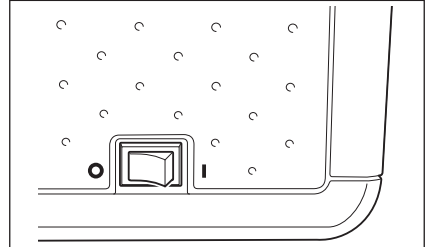

2. Connect the AC adapter's connector plug to the adapter's terminal.

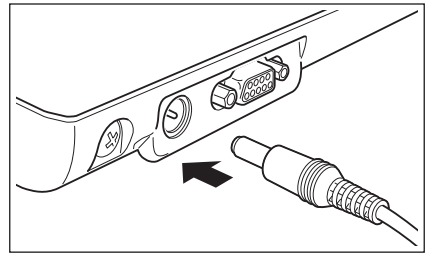

3. Insert the AC adapter power plug into an AC outlet (100 to 240 VAC, 50-60 Hz).

Turning power ON/OFF

[Procedure]

Turning power ON

1. Turn the power switch to the “I”.
The power will be turned ON (energized).

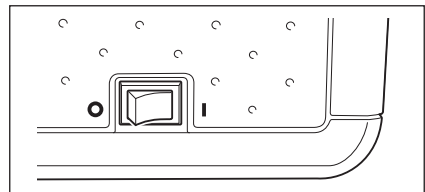

[Procedure]

Turning power OFF

1. Turn the power switch to the “○”.
The power will be turned OFF.

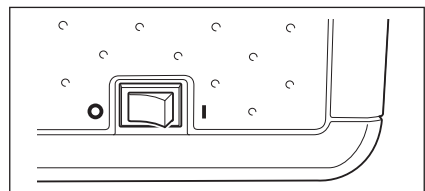

Items You Must Know

Initial Settings of the CM-5

When the instrument is turned ON, “Welcome to Easy Setup Wizard!” will appear automatically in English. For normal measurement, you do not need to change the initial settings.

Nevertheless, you can check the date setting or change the display language before using the instrument. To do so, use the <Configuration> screen.

The display language can be selected from eight languages including English.

For details, refer to page 93 “Other Settings”.

Control Panel

The front of the CM-5 contains the LCD screen on which the instrument displays measurement results and messages, and the control buttons which are used to set measurement options or to change displays.

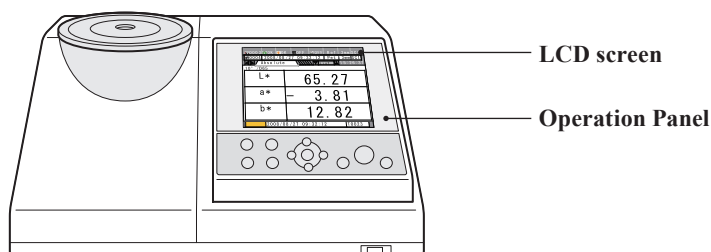

Screen Display (LCD Screen)

The LCD screen displays measurement settings, measurement results and messages. It also indicates the status of the instrument with icons.

The basic screen layout is shown below.

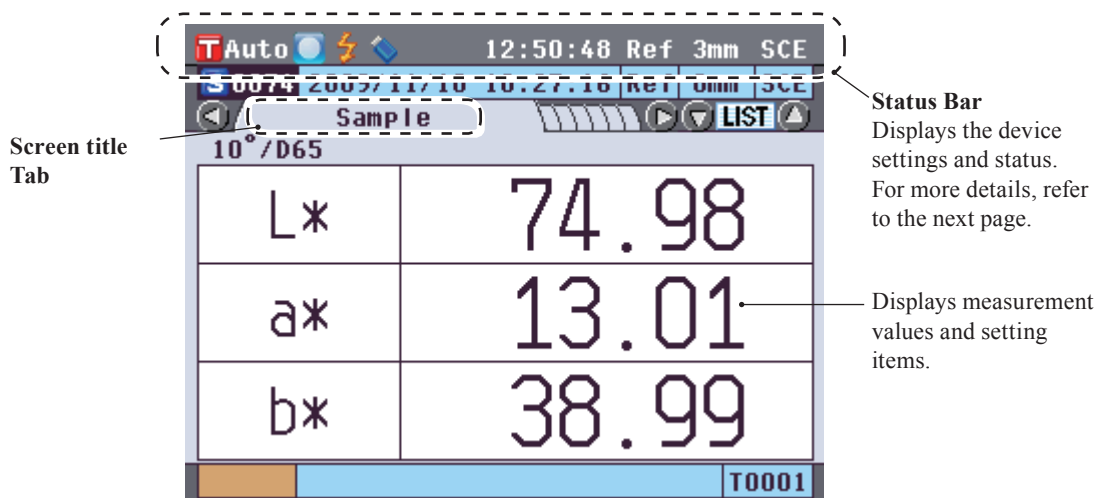

Status Bar



	Display	Description (Status)	Meaning
1	xxxx / Auto	Active Target number	Target number currently set in the instrument/ Auto Target set to ON
2	/ / / None	Calibrating	Zero Calibration / White Calibration / User Calibration not performed or Calibration is complete
3	None /	Flash ready	Measurement possible or not possible
4	None /	USB Memory Device	Connected or not connected
5	None /	Serial Printer	Automatic printing ON/OFF
6	xx:xx:xx	Current time	Hour : Minute : Second
7	Ref / Tra / Pet / Liq	Measurement Type	Reflectance measurement/Transmittance measurement/Petri Dish measurement/ Liquid measurement
8	30 mm / 8 mm / 3 mm	Measurement area	ø30 mm / ø8 mm / ø3 mm
9	SCE / SCI	Specular component	SCE (Specular Component Excluded) / SCI (Specular Component Included)

Control Buttons

Use these buttons to set items or change screens according to the guide on the LCD screen.

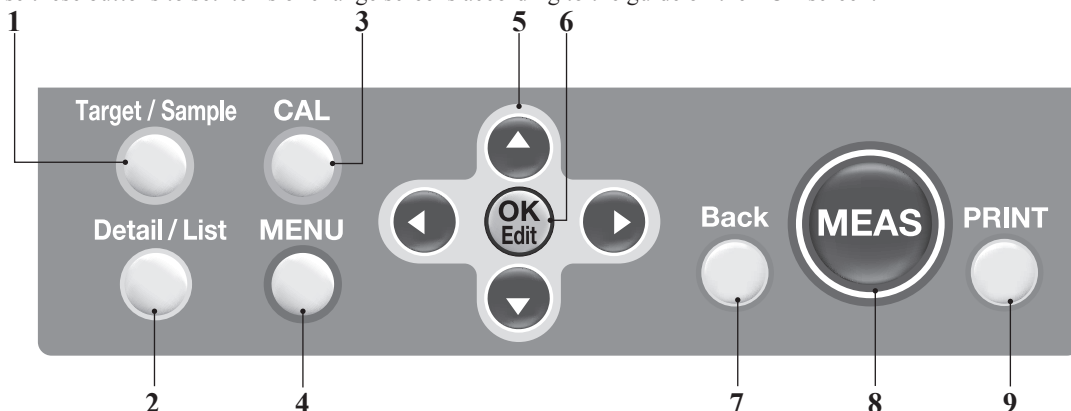

- | | | |
|---|--|---|
| 1 | [Target/Sample] button | Switches between <Target> screen and <Sample> screen. |
| 2 | [Detail/List] button | When the <Sample> or <Target> screen is displayed, use this button to switch between the detail display and list display. |
| 3 | [CAL] button | Displays the <Calibration> screen. |
| 4 | [MENU] button | Displays the <Configuration> screen.
Holding down the [MENU] button displays the <Welcome to Easy Setup Wizard!> screen. |
| 5 | Cursor key
(◀ / ▲ / ▼ / ▶) | Moves the cursor on the screen or changes the selected value.
To determine the item indicated by the cursor, press the [OK/Edit] button. |
| 6 | [OK/Edit] button | Sets the item indicated by the cursor or saves the setting. |
| 7 | [Back] button | Cancels the setting or returns to the previous step on each setting screen. |
| 8 | [MEAS] button | Performs calibration or measurement. |
| 9 | [PRINT] button | Outputs the sample data to the connected serial printer. |

Memo Enabling/Disabling Control Buttons
Buttons for this instrument can be enabled or disabled as desired using the optional Color Management Software SpectraMagic™ NX (CM-S100w), such as to enable just the [MEAS] button.
For more information, refer to the information for the “Standalone Configuration” dialog box of the Color Management Software SpectraMagic™ NX (CM-S100w).

The screen will change depending on the button operation.

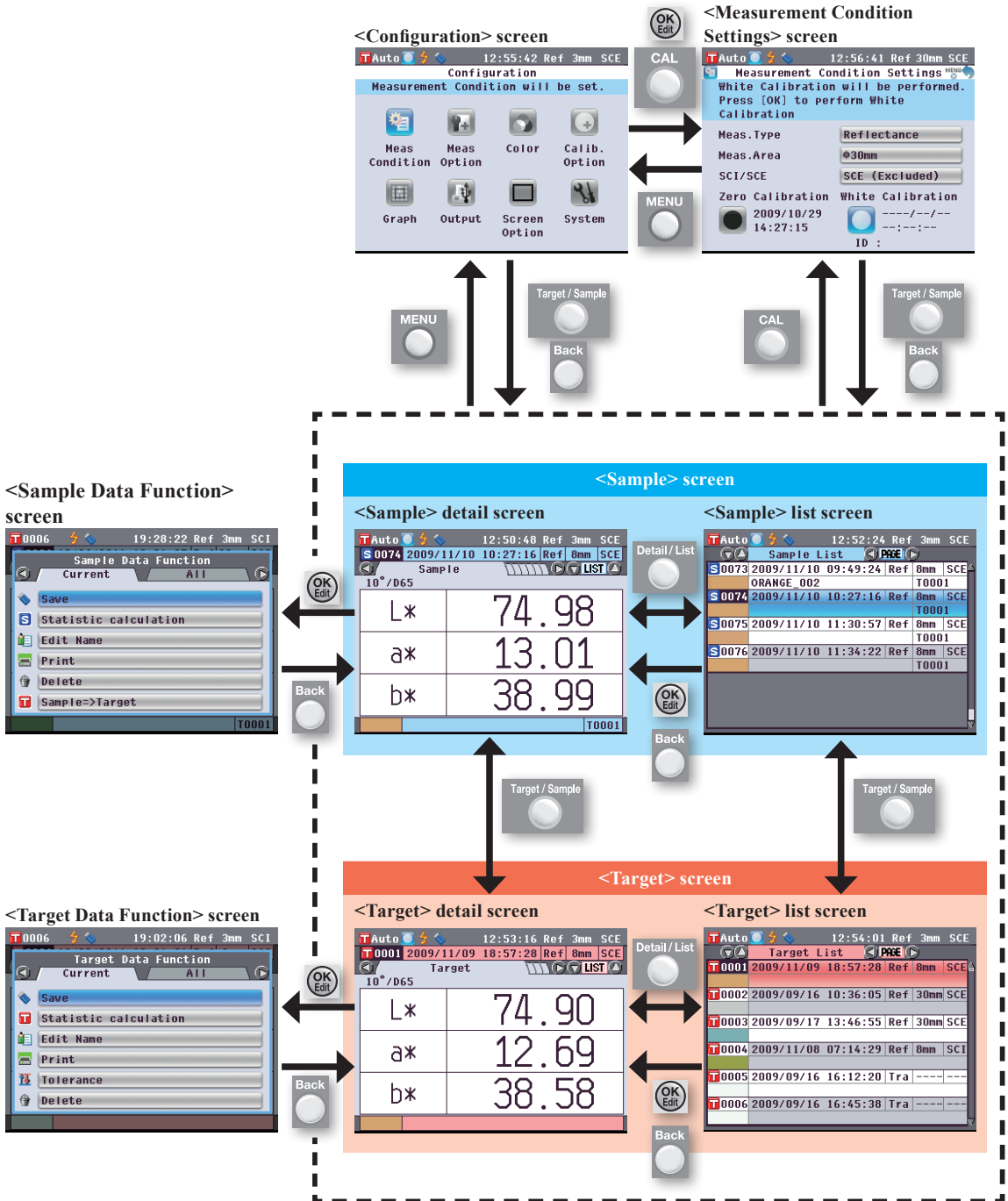

Data Saving

Data used with this instrument are saved automatically.

Chapter 2

Preparation for Measurement

2

Preparation for Measurement

Flow of Measurement

■ Optional settings

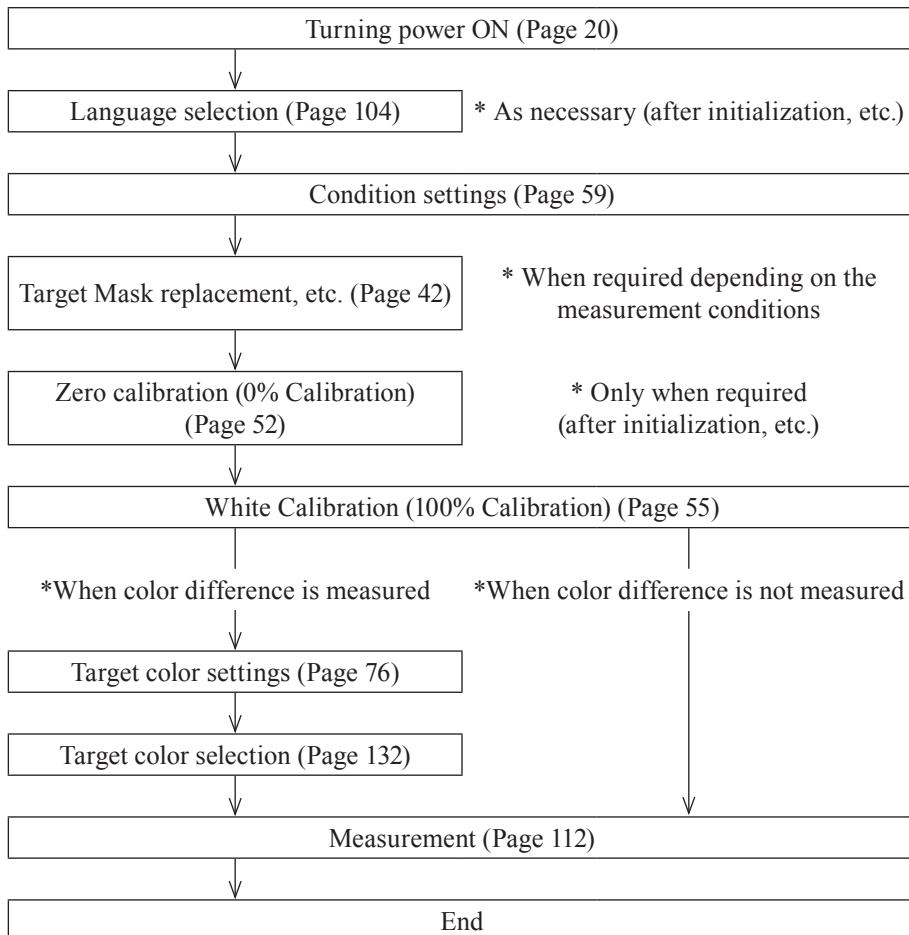

■ Basic procedure



Quick Setting Wizard



When you use the instrument for the first time, you can set the measurement conditions and calibrate the instrument step by step by following the instructions on the screen.

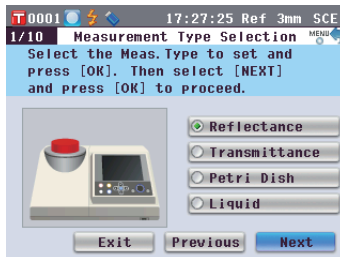
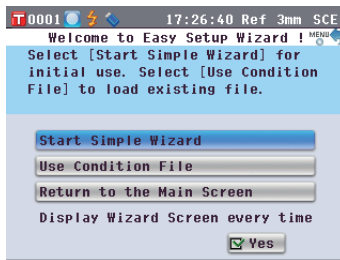

[Procedure]

1. Turn the instrument ON. The <Welcome to Easy Setup Wizard!> screen appears after the initial screen.
 - The Easy Setup Wizard can also be entered by holding the [Menu] button pressed for a long time.
 - If you want to save condition settings to a USB memory device, connect a USB memory device to the instrument before continuing.
2. Use the  or  button of the cross key to move the cursor to “Start Simple Wizard” and then press the [OK/Edit] button.
3. The <Measurement Type Selection> screen appears.



Memo

To move the cursor to select a setting item, press the  or  button of the cross key.

To move the cursor between “Exit”, “Previous” and “Next”, press the  or  button of the cross key.

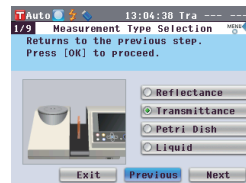
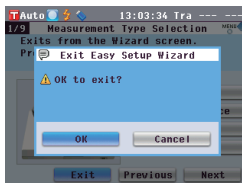
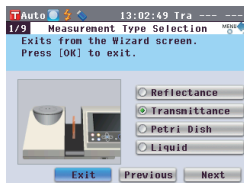
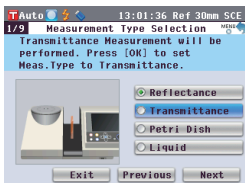

When you select “Exit” and then press the [OK/Edit] button, the wizard is interrupted and the <Sample> screen is displayed.

When you select “Previous” and then press the [OK/Edit] button, the screen which was displayed immediately before the Quick Setting Wizard is displayed.



4. Go to the appropriate step according to the measurement type.
 - <Reflectance measurement> Refer to Steps 4 to 20 (Pages 30 to 33).
 - <Reflectance measurement using Petri Dish> Refer to Steps 4 to 18 (Pages 33 to 36).
 - <Transmittance measurement> Refer to Steps 4 to 13 (Pages 37 to 39).
 - <Liquid transmittance measurement> Refer to Steps 4 to 12 (Pages 39 to 41).

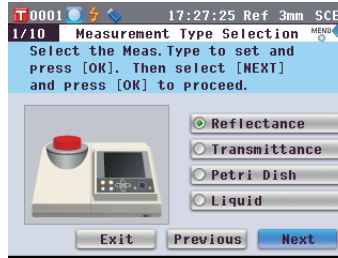

<Reflectance measurement>

- Use the  or  button of the cross key to move the cursor to “Reflectance” and then press the [OK/Edit] button.
The cursor moves to “Next”.



- Press the [OK/Edit] button.

- The <Measurement Area Selection> screen appears.

Use the  or  button of the cross key to move the cursor to the desired measurement area and then press the [OK/Edit] button.

The cursor moves to “Next”.

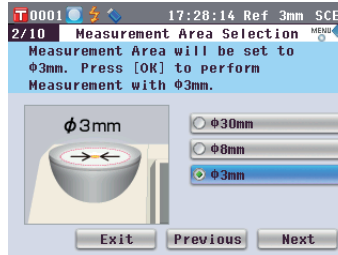

- Press the [OK/Edit] button.

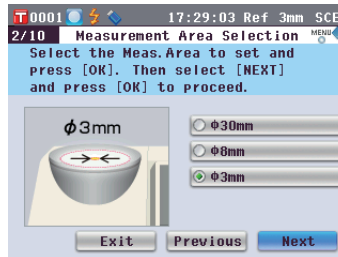

- The <Target Mask Setting> screen appears.

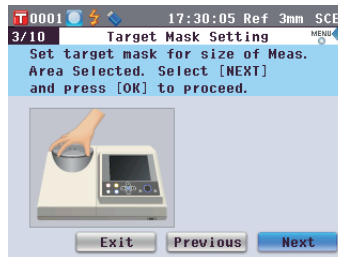

- Attach the Target Mask for the size of the measurement area selected.

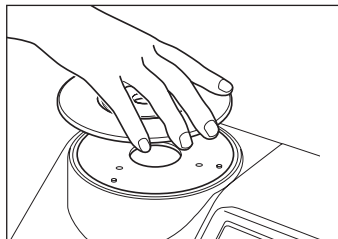

- Check that the cursor is on “Next”, and press the [OK/Edit] button.



Memo

For the procedure of attaching the Target Mask, refer to page 42.

11. The <Specular Component Selection> screen appears.

Use the  or  button of the cross key to move the cursor to the desired specular component and then press the [OK/Edit] button.

The cursor moves to “Next”.

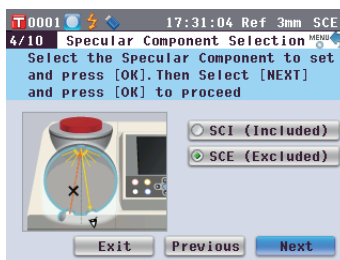

12. Press the [OK/Edit] button.

13. The <Meas. Condition Confirmation> screen appears.

Check that the cursor is on “Next”, and press the [OK/Edit] button.

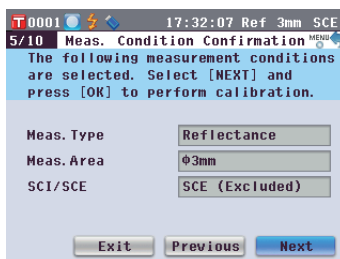

14. The <Zero Calibration> screen appears.

The following is the explanation when zero calibration will be skipped.

15. Check that the cursor is on “Next”, and press the [OK/Edit] button.

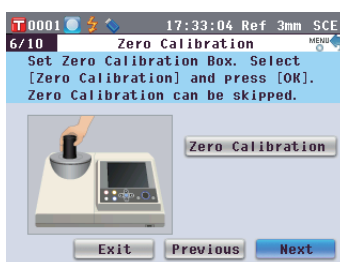

Memo

Since the CM-5 stores the data of the zero calibration performed at the factory, it is unnecessary to repeat the zero calibration every time you turn ON the instrument. For details of zero calibration, refer to page 52.

16. The <White Calibration> screen appears.

Check that the cursor is on “White Calibration”, and press the [OK/Edit] button.

White calibration is performed by using the built-in White Calibration Plate of the instrument.

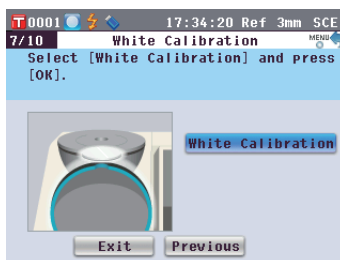

Memo

For details of white calibration, refer to page 55.

17. When the white calibration is completed, the **<Auto White Cal. Selection>** screen appears.

Settings:

“Automatic”: White calibration will be performed automatically immediately after instrument is switched on.

“Manual”: White calibration must be performed manually before taking measurements.

To change settings, use the **▲** or **▼** button of the cross key to move the cursor to the desired setting and then press the **[OK/Edit]** button.

The cursor moves to “Next”.

18. Check that the cursor is on “Next”, and press the **[OK/Edit]** button.

19. If a USB memory device is not connected, the **<Meas. Cond. Settings completed>** screen appears. Skip to step 20.

If a USB memory device is connected, the **<Save Condition File>** screen appears.

If the condition file will not be saved: Check that the cursor is on “Next”, and press the **[OK/Edit]** button. The **<Meas. Cond. Settings completed>** screen appears. Skip to step 20.

To change the file name:

Use the **▲** or **▼** button of the cross key to move the cursor to the current file name and press the **[OK/Edit]** button. The **<Edit Name>** screen will appear.

Use the cross key buttons to move the cursor to the desired character and press the **[OK/Edit]** button to confirm it. Press the **[CAL]** button to erase characters.

When the file name has been input, press the **[MENU]** button to move the cursor to “Save”, and press the **[OK/Edit]** button to confirm the file name and close the screen.

To change a file name using the USB keyboard, remove the USB memory device while on the name editing screen, and input the name after connecting the USB keyboard.

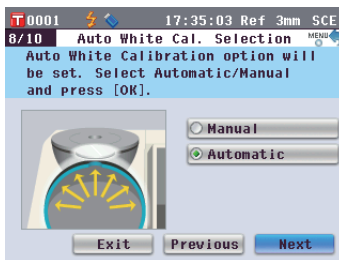

Memo

Automatic white calibration is convenient if measurements are almost always performed without changing the measurement type or other measurement conditions each time.

For details of automatic white calibration, refer to page 55.

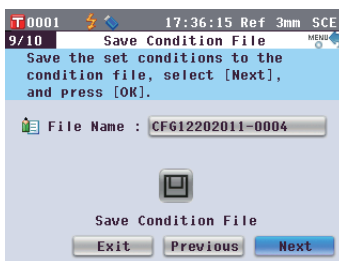

Memo

The USB memory device must be connected to the instrument before saving the condition file to a USB memory device. For information on connecting a USB memory device, refer to page 141 “Connecting a USB Memory”.

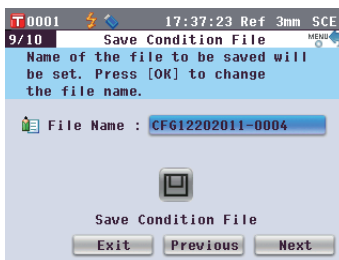

Memo

A USB keyboard can also be used to input file names. For information on connecting a USB keyboard, refer to page 143 “Connecting a USB Keyboard”.



Notes

Keyboard input is not possible if the cursor is in the file name input field. Use the **▲** or **▼** button of the cross key to move the cursor to the input character before inputting with the keyboard.

To save the condition file:

Verify that a USB memory device is connected.

Use the  or  button of the cross key to move the cursor to  and press the [OK/Edit] button.



After the condition file has been saved, the <Meas. Cond. Settings completed> screen appears.

20. Check that the cursor is on “Finish”, and press the [OK/Edit] button.

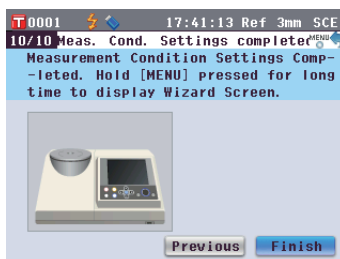
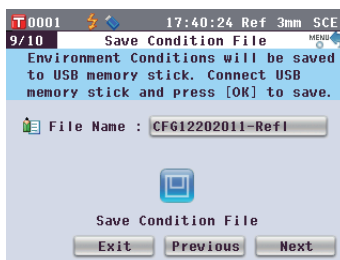
The Easy Setup Wizard is completed and the <Sample> screen appears.



<Reflectance measurement using Petri Dish>



4. Use the  or  button of the cross key to move the cursor to “Petri Dish” and then press the [OK/Edit] button.

The cursor moves to “Next”.

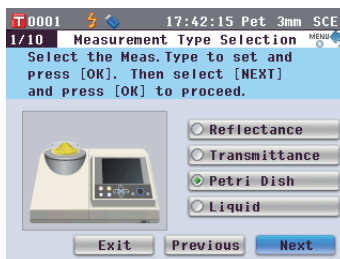
5. Press the [OK/Edit] button.



6. The <Measurement Area Selection> screen appears.

Use the  or  button of the cross key to move the cursor to the desired measurement area and then press the [OK/Edit] button.

The cursor moves to “Next”.

7. Press the [OK/Edit] button.

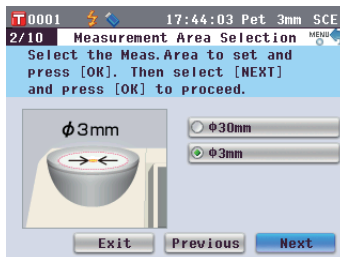
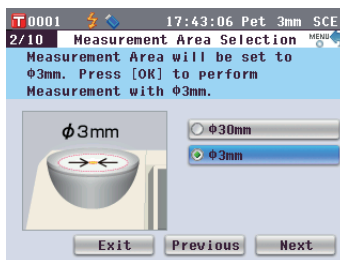

8. The <Target Mask Setting> screen appears.

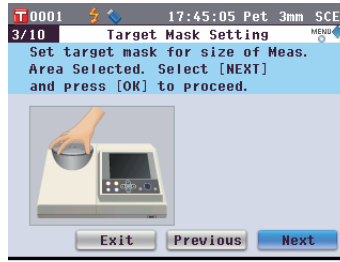

9. Attach the optional Target Mask (for Petri Dish) if $\phi 30\text{mm}$ was selected or the optional Target Mask (for Mini Petri Dish) if $\phi 3\text{mm}$ was selected in step 6 above.



Memo

For the procedure of attaching the Target Mask, refer to page 42.

10. Check that the cursor is on “Next”, and press the [OK/Edit] button.

11. The <Meas. Condition Confirmation> screen appears.

Check that the cursor is on “Next”, and press the [OK/Edit] button.

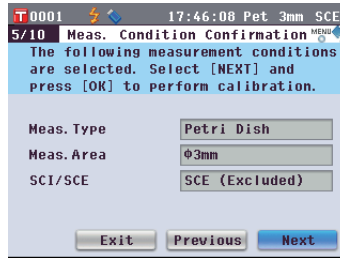

12. The <Zero Calibration> screen appears.

The following is the explanation when zero calibration will be skipped.

13. Check that the cursor is on “Next”, and press the [OK/Edit] button.

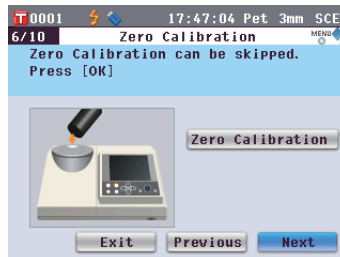

Memo

Since the CM-5 stores the data of the zero calibration performed at the factory, it is unnecessary to repeat the zero calibration every time you turn ON the instrument. For details of zero calibration, refer to page 52.

14. The <White Calibration> screen appears.

Check that the cursor is on “White Calibration”, and press the [OK/Edit] button.

White calibration is performed by using the built-in White Calibration Plate of the instrument.

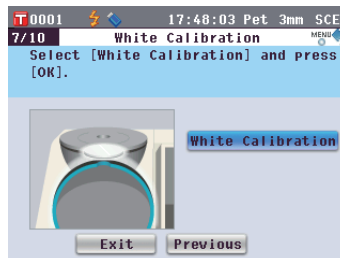

Memo

For details of white calibration, refer to page 55.

15. When the white calibration is completed, the **<Auto White Cal. Selection>** screen appears.

Settings:

“Automatic”: White calibration will be performed automatically immediately after instrument is switched on.

“Manual”: White calibration must be performed manually before taking measurements.

To change settings, use the **▲** or **▼** button of the cross key to move the cursor to the desired setting and then press the **[OK/Edit]** button.

The cursor moves to “Next”.

16. Check that the cursor is on “Next”, and press the **[OK/Edit]** button.

17. If a USB memory device is not connected, the **<Meas. Cond. Settings completed>** screen appears. Skip to step 18.

If a USB memory device is connected, the **<Save Condition File>** screen appears.

If the condition file will not be saved: Check that the cursor is on “Next”, and press the **[OK/Edit]** button. The **<Meas. Cond. Settings completed>** screen appears. Skip to step 18.

To change the file name:

Use the **▲** or **▼** button of the cross key to move the cursor to the current file name and press the **[OK/Edit]** button. The **<Edit Name>** screen will appear.

Use the cross key buttons to move the cursor to the desired character and press the **[OK/Edit]** button to confirm it. Press the **[CAL]** button to erase characters.

When the file name has been input, press the **[MENU]** button to move the cursor to “Save”, and press the **[OK/Edit]** button to confirm the file name and close the screen.

To change a file name using the USB keyboard, remove the USB memory device while on the name editing screen, and input the name after connecting the USB keyboard.

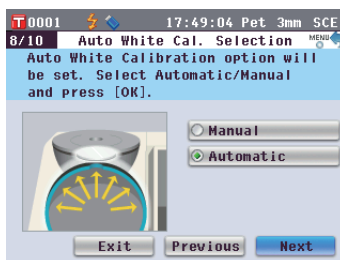

Memo

Automatic white calibration is convenient if measurements are almost always performed without changing the measurement type or other measurement conditions each time.

For details of automatic white calibration, refer to page 55.

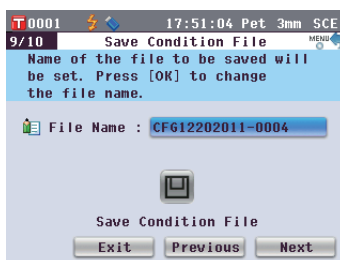
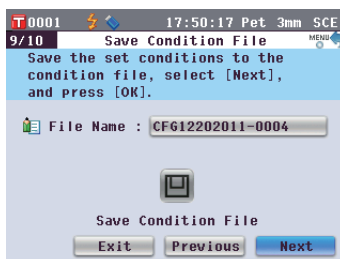

Memo

A USB keyboard can also be used to input file names. For information on connecting a USB keyboard, refer to page 143 “Connecting a USB Keyboard”.

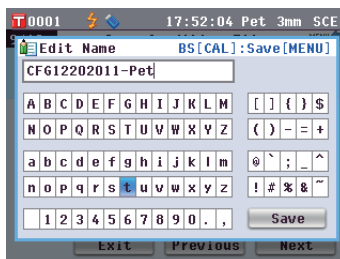

Notes

Keyboard input is not possible if the cursor is in the file name input field. Use the **▲** or **▼** button of the cross key to move the cursor to the input character before inputting with the keyboard.

To save the condition file:

Verify that a USB memory device is connected.

Use the  or  button of the cross key to move the cursor to  and press the [OK/Edit] button.

After the condition file has been saved, the <Meas. Cond. Settings completed> screen appears.

18. Check that the cursor is on “Finish”, and press the [OK/Edit] button.

The Easy Setup Wizard is completed and the <Sample> screen appears.

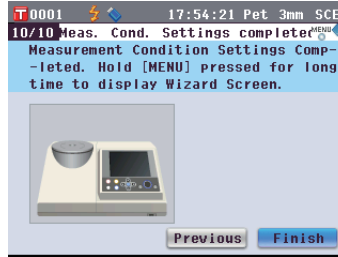
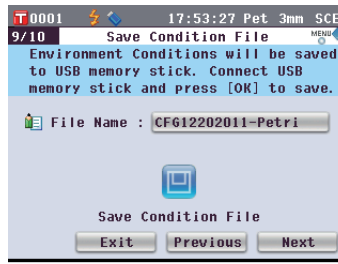

<Transmittance measurement>

- Use the **▲** or **▼** button of the cross key to move the cursor to the “Transmittance” and then press the **[OK/Edit]** button.

The cursor moves to “Next”.

- Press the **[OK/Edit]** button.

- The <Meas. Condition Confirmation> screen appears.

Check that the cursor is on “Next”, and press the **[OK/Edit]** button.

- The <0% Calibration> screen appears.

The following is the explanation when 0% calibration will be skipped.

- Check that the cursor is on “Next”, and press the **[OK/Edit]** button.

- The <100% Calibration> screen appears.

Check that the Transmittance Specimen Chamber is empty and that the cursor is on “100% Calibration”, and press the **[OK/Edit]** button.

100% calibration will be performed.

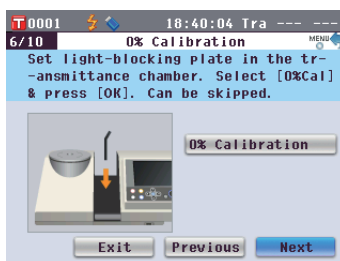
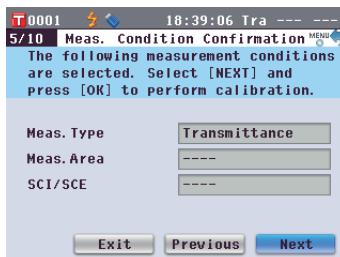
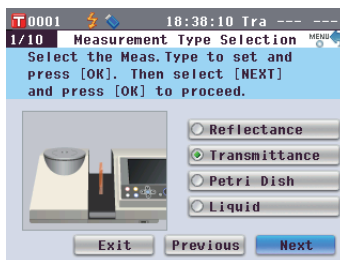

Memo

Since the CM-5 stores the data of the 0% calibration performed at the factory, it is unnecessary to repeat the 0% calibration every time you turn ON the instrument. For details of 0% calibration, refer to page 52.

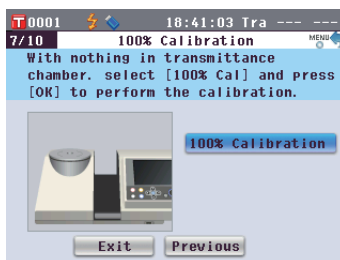

Memo

For details of 100% calibration, refer to page 55.

10. When the 100% calibration is completed, the **<Auto 100% Cal. Selection>** screen appears.

Settings:

“Automatic”: 100% calibration will be performed automatically immediately after instrument is switched on.

“Manual”: 100% calibration must be performed manually before taking measurements.

To change settings, use the **▲** or **▼** button of the cross key to move the cursor to the desired setting and then press the **[OK/Edit]** button.

The cursor moves to “Next”.

11. Check that the cursor is on “Next”, and press the **[OK/Edit]** button.

12. If a USB memory device is not connected, the **<Meas. Cond. Settings completed>** screen appears. Skip to step 13.

If a USB memory device is connected, the **<Save Condition File>** screen appears.

If the condition file will not be saved: Check that the cursor is on “Next”, and press the **[OK/Edit]** button. The **<Meas. Cond. Settings completed>** screen appears. Skip to step 13.

To change the file name:

Use the **▲** or **▼** button of the cross key to move the cursor to the current file name and press the **[OK/Edit]** button. The **<Edit Name>** screen will appear.

Use the cross key buttons to move the cursor to the desired character and press the **[OK/Edit]** button to confirm it. Press the **[CAL]** button to erase characters.

When the file name has been input, press the **[MENU]** button to move the cursor to “Save”, and press the **[OK/Edit]** button to confirm the file name and close the screen. To change a file name using the USB keyboard, remove the USB memory device while on the name editing screen, and input the name after connecting the USB keyboard.

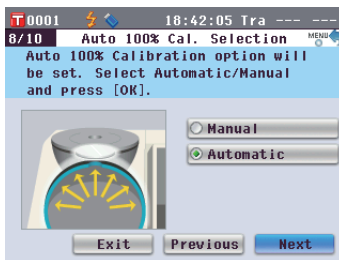

Memo

For details of 100% calibration, refer to page 55.

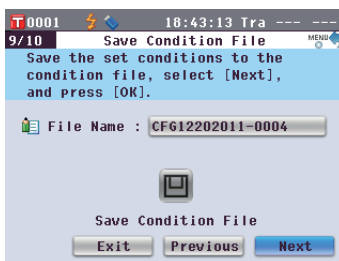

Memo

Automatic 100% calibration is convenient if measurements are almost always performed without changing the measurement type or other measurement conditions each time. For details of automatic 100% calibration, refer to page 55.

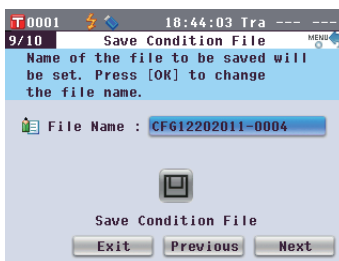

Memo

A USB keyboard can also be used to input file names. For information on connecting a USB keyboard, refer to page 143 “Connecting a USB Keyboard”.



Notes

Keyboard input is not possible if the cursor is in the file name input field. Use the **▲** or **▼** button of the cross key to move the cursor to the input character before inputting with the keyboard.

To save the condition file:

Verify that a USB memory device is connected.



Use the  or  button of the cross key to move the cursor to  and press the [OK/Edit] button.

After the condition file has been saved, the <Meas. Cond. Settings completed> screen appears.

13. Check that the cursor is on “Finish”, and press the [OK/Edit] button.

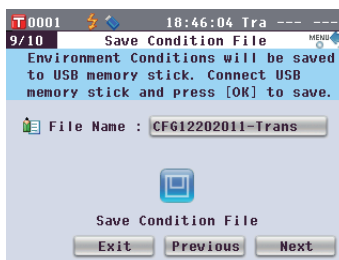
The Easy Setup Wizard is completed and the <Sample> screen appears.

**<Liquid transmittance measurement>**

4. Use the  or  button of the cross key to move the cursor to “Liquid” and then press the [OK/Edit] button.

The cursor moves to “Next”.

5. Press the [OK/Edit] button.

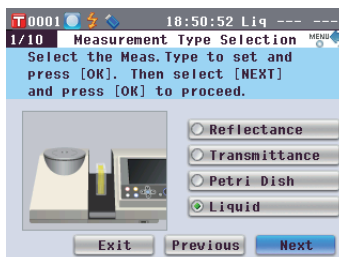

6. The <Meas. Condition Confirmation> screen appears.

Check that the cursor is on “Next”, and press the [OK/Edit] button.

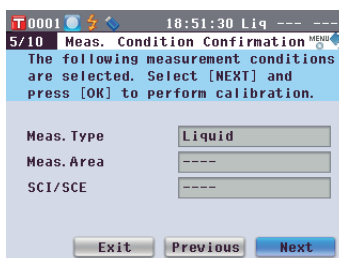

7. The <0% Calibration> screen appears.

The following is the explanation when zero calibration will be skipped.

8. Check that the cursor is on “Next”, and press the [OK/Edit] button.

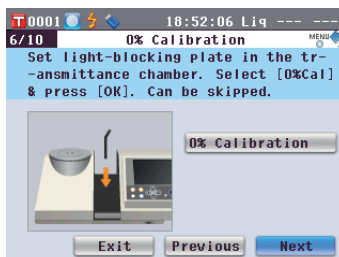
**Memo**

Since the CM-5 stores the data of the 0% calibration performed at the factory, it is unnecessary to repeat the 0% calibration every time you turn ON the instrument. For details of 0% calibration, refer to page 52.

9. The <100% Calibration> screen appears.

Place a specimen for 100% calibration (a container containing a liquid with high transmittance such as distilled water) in the Transmittance Specimen Chamber

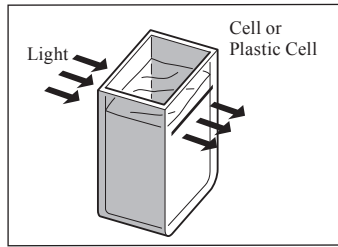

Memo

For details of 100% calibration, refer to page 55.

10. Check that the cursor is on “100% Calibration”, and then press the [OK/Edit] button. 100% calibration will be performed.

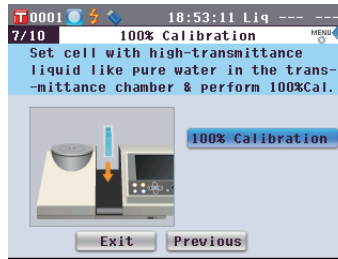

11. When the 100% calibration is completed:

If a USB memory device is not connected, the <Meas. Cond. Settings completed> screen appears. Skip to step 12.

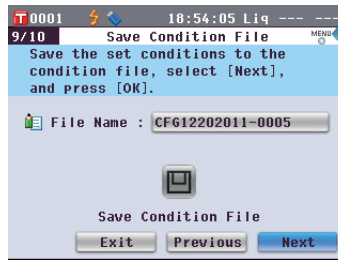

If a USB memory device is connected, the < Save Condition File > screen appears.

If the condition file will not be saved: Check that the cursor is on “Next”, and press the [OK/Edit] button. The <Meas. Cond. Settings completed> screen appears. Skip to step 12.

To change the file name:

Use the or button of the cross key to move the cursor to the current file name and press the [OK/Edit] button. The <Edit Name> screen will appear.

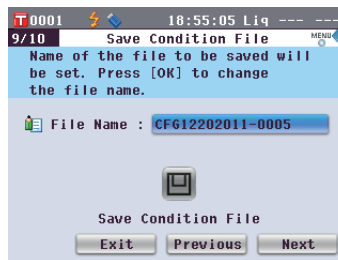

Use the cross key buttons to move the cursor to the desired character and press the [OK/Edit] button to confirm it. Press the [CAL] button to erase characters.

When the file name has been input, press the [MENU] button to move the cursor to “Save”, and press the [OK/Edit] button to confirm the file name and close the screen.

To change a file name using the USB keyboard, remove the USB memory device while on the name editing screen, and input the name after connecting the USB keyboard.

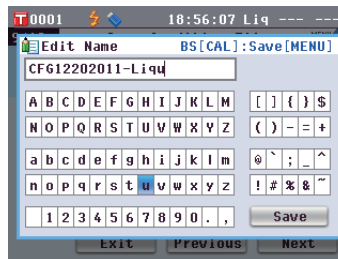

Memo

A USB keyboard can also be used to input file names. For information on connecting a USB keyboard, refer to page 143 “Connecting a USB Keyboard”.

To save the condition file:

Verify that a USB memory device is connected.

Use the  or  button of the cross key to move the cursor to  and press the **[OK/Edit] button**.

After the condition file has been saved, the **<Meas. Cond. Settings completed>** screen appears.

12. Check that the cursor is on “Finish”, and press the [OK/Edit] button.

The Easy Setup Wizard is completed and the **<Sample>** screen appears.

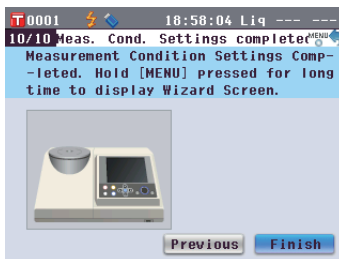
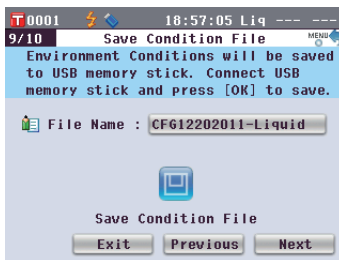
**Memo**

The USB memory device must be connected to the instrument before saving the condition file to a USB memory device. For information on connecting a USB memory device, refer to page 141 “Connecting a USB Memory”.

Setting a specimen

Reflectance measurement

To use the instrument for reflectance measurement of specimens other than powder or paste, attach the Target Mask to the specimen measuring port and set a specimen on it. The Target Mask can be selected from three types based on the illumination area (specimen measuring port size): $\phi 30$ mm, $\phi 8$ mm and $\phi 3$ mm, depending on the specimen and application.

Notes When taking reflectance measurements, make sure that there is no object in the transmittance specimen chamber.

Required accessory

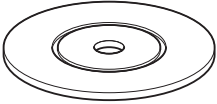
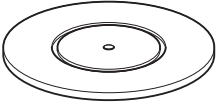
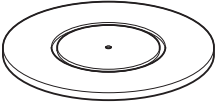
<p>Target Mask: $\phi 30$ mm CM-A197</p>  <p>For LAV</p>	<p>Target Mask: $\phi 8$ mm CM-A196 (Optional)</p>  <p>For MAV</p>	<p>Target Mask: $\phi 3$ mm CM-A195 (Optional)</p>  <p>For SAV</p>
---	---	--

Notes Do not touch the inside (edge) of the Target Masks with your fingers. If it becomes dirty, wipe it with a soft, clean dry cloth.

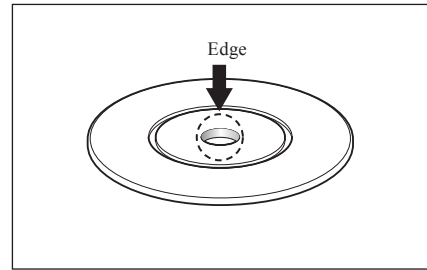

Attaching the Target Mask to the instrument

1. Align the Target Mask with the positioning groove on the instrument and push the mask in.

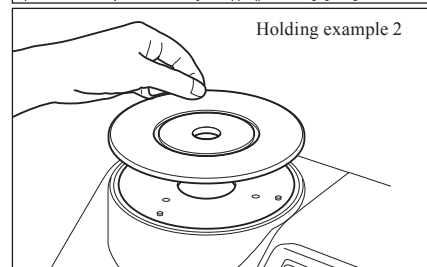
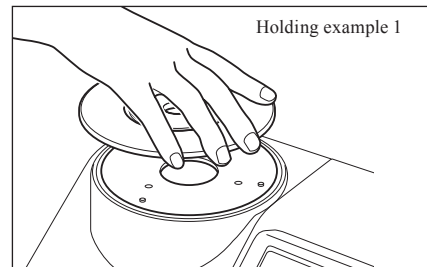









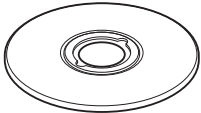

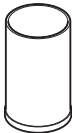
Petri Dish/Mini Petri Dish measurements

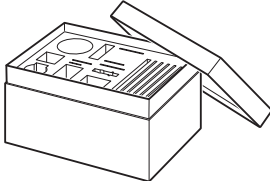
Use a Petri Dish or Mini Petri Dish to allow the instrument to measure the reflectance of powder or paste specimens. The Mini Petri Dish enables measurements with much smaller amounts of specimens.

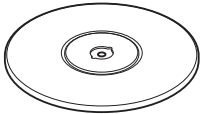
Notes When taking reflectance measurements, make sure that there is no object in the transmittance specimen chamber.

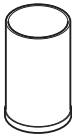
Required accessory

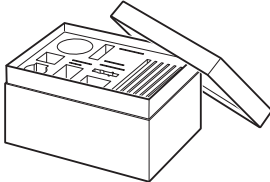
Petri Dish Measurement Set CM-A205 (Optional)		
Petri Dish: CM-A128 	Target Mask for Petri Dish: CM-A203 	Calibration Glass for Petri Dish: CM-A212 
Zero Calibration Box: CM-A124 	White Calibration Plate: CM-A210 (with CD-ROM containing calibration data and data-setting software) 	Accessory Case: CM-A193 
Mini Petri Dish Measurement Set CM-A164 (Optional)		
Mini Petri Dish: CM-A157 	Target Mask for Mini Petri Dish: CM-A158 	Calibration Glass for Mini Petri Dish: CM-A159 
Zero Calibration Box: CM-A124 	White Calibration Plate: CM-A210 (with CD-ROM containing calibration data and data-setting software) 	Accessory Case: CM-A193 

Notes

Be careful that the bottom of the Petri Dish or Mini Petri Dish or the Calibration Glass (for Petri Dish) or Calibration Glass (for Mini Petri Dish) does not get scratched or stained, or get fingerprints on it. If it becomes dirty, wipe it with a soft, clean dry cloth. If dirt is difficult to remove, wipe it off with a cloth dampened with commercially-available cleaning solution. Then remove the solution with a cloth dampened with water and allow the plate to dry. If the scratch or stain cannot be removed, replace the Petri Dish, Mini Petri Dish, Calibration Glass (for Petri Dish), or the Calibration Glass (for Mini Petri Dish).

Notes

When the Zero Calibration Box is not in use, be sure to attach the cap to prevent the entry of dust. If dust enters the box, blow it off with a commercially-available blower.

Be careful that the inner surface of the Zero Calibration Box (black-coated side) does not get scratched or stained. If the scratch or stain cannot be removed, replace the Zero Calibration Box.

Notes

The White Calibration Plate (optional accessory) may become discolored if left exposed to light. Therefore, make sure to close the cap when it is not in use so that the White Calibration Plate is not exposed to ambient light.

Do not allow the White Calibration Plate (optional accessory) to get scratched or stained, or get fingerprints on it. If it becomes dirty, wipe it with a soft, clean dry cloth. If dirt is difficult to remove, wipe it off with a cloth dampened with commercially-available cleaning solution. Then remove the solution with a cloth dampened with water, and leave the plate to dry. If the scratch or stain cannot be removed, replace the White Calibration Plate.

When you replace the White Calibration Plate (optional accessory), use the data of the new White Calibration Plate to overwrite the white calibration data stored in the instrument as user calibration data.

Attaching the Target Mask to the instrument

1. Align the Target Mask (for Petri Dish) or Target Mask (for Mini Petri Dish) with the positioning groove on the instrument and push the mask in.

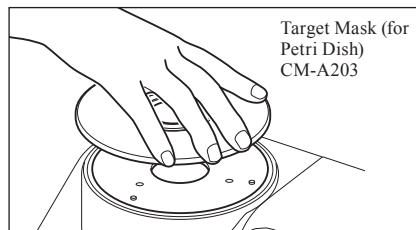

Notes Although automatic zero and white calibration can be performed when using the Petri Dish or Mini Petri Dish and are sufficient for relative measurements comparing samples with a target, for the highest accuracy, zero calibration and white calibration should be performed using the Zero Calibration Box CM-A124 and White Calibration Plate CM-A210 respectively together with the Calibration Glass (for Petri Dish) CM-A212 or Calibration Glass (for Mini Petri Dish) CM-A159.

<To perform zero calibration>

2. When using the Petri Dish: Insert the Calibration Glass (for Petri Dish) into the recess in the Target Mask (for Petri Dish).

When using the Mini Petri Dish, insert the Calibration Glass (for Mini Petri Dish) into the recess in the Target Mask (for Mini Petri Dish).

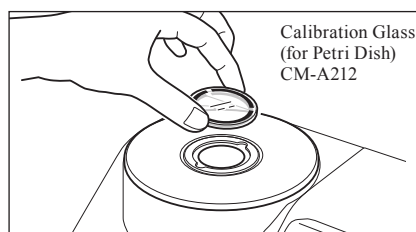

3. Align the Zero Calibration Box with the positioning groove on the Target Mask (for Petri Dish) or Target Mask (for Mini Petri Dish) and push the box in.

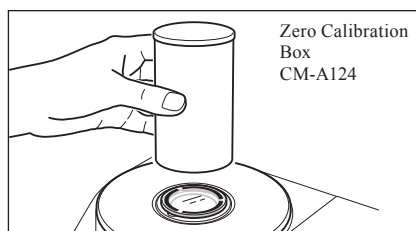

<To perform white calibration>

Normally, calibration is performed using the built-in White Calibration Plate inside the shutter, so there is no need to set the calibration plate. Use the following procedure to perform white calibration as user calibration using an optional White Calibration Plate.

2. When using the Petri Dish: Insert the Calibration Glass (for Petri Dish) into the recess in the Target Mask (for Petri Dish).

When using the Mini Petri Dish, insert the Calibration Glass (for Mini Petri Dish) into the recess in the Target Mask (for Mini Petri Dish).

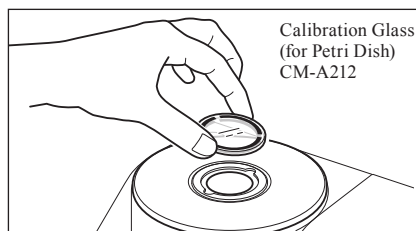

3. Align the White Calibration Plate with the positioning groove on the Target Mask (for Petri Dish) or Target Mask (for Mini Petri Dish) and push the plate in.

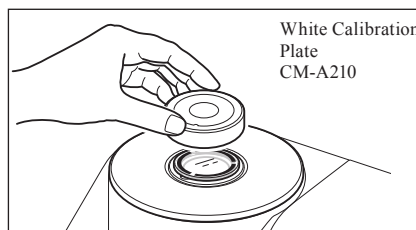

<To measure a specimen>

- 2. When using the Petri Dish: Insert the Petri Dish containing a specimen into the recess in the Target Mask (for Petri Dish).**

When using the Mini Petri Dish:

Insert the Mini Petri Dish containing a specimen into the recess in the Target Mask (for Mini Petri Dish). Then, carefully place the Zero Calibration Box over the Mini Petri Dish containing the specimen, align the Zero Calibration Box with the positioning groove on the Target Mask (for Mini Petri Dish) and press down.

When using the Mini Petri Dish, the small amount of specimen used may result in external light penetrating the specimen and affecting measurements. For this reason, the Zero Calibration Box should be used to cover the Mini Petri Dish containing the specimen to block out external light during measurements.

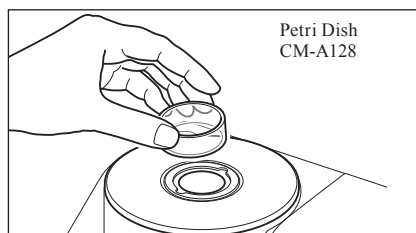

Specimen Viewing Mirror (Optional)

The Specimen Viewing Mirror allows you to check the measurement points for a specimen when using the instrument for reflectance measurement.

How to use the Specimen Viewing Mirror

1. Place a specimen on the Target Mask.

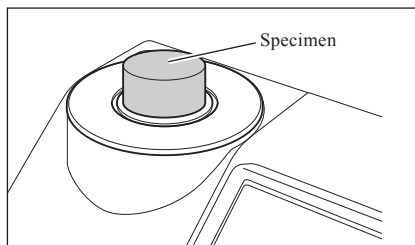

2. Open the Transmittance Specimen Chamber Cover and set the Specimen Viewing Mirror on the Chamber.

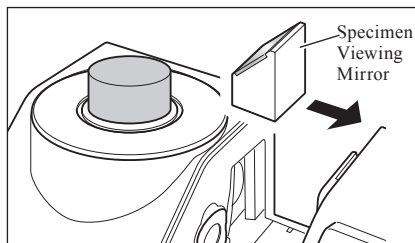

3. Open the shutter.

For the procedure of opening/closing the shutter, refer to page 66.

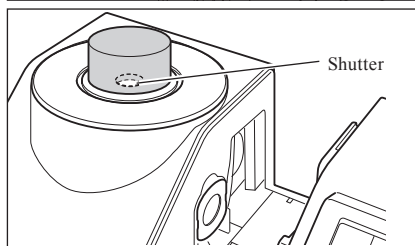

4. Look into the Specimen Viewing Mirror from the Top and adjust the position of the specimen.

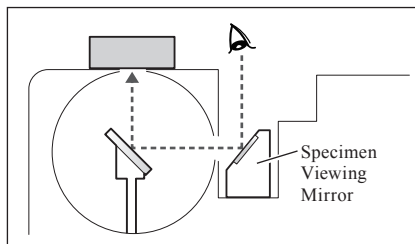

5. Close the shutter.

For the procedure of opening/closing the shutter, refer to page 66.

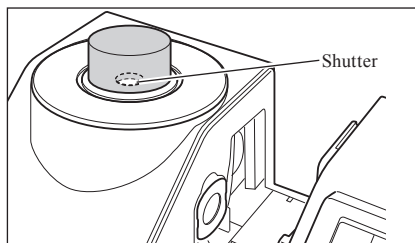

6. Remove the Specimen Viewing Mirror and close the Transmittance Specimen Chamber Cover.

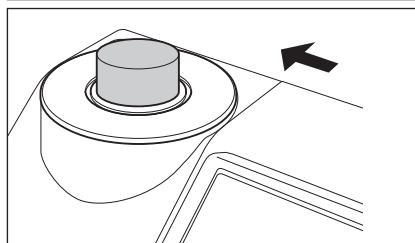







Transmittance Measurement and Liquid Measurement

To use the instrument for transmittance measurement, attach the Transmittance Mask on the illumination window of the Transmittance Specimen Chamber and then set a specimen.

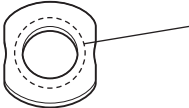
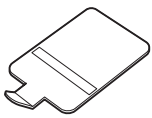
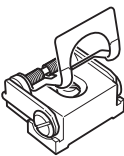
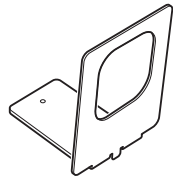
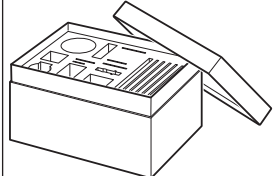
The Transmittance Measurement Set allows you to set a container containing a liquid specimen or a specimen in the form of plate or film easily and reliably.

To conduct measurement using a commercially-available 10 mm-wide Cell, using the 10 mm Wide Cell Measurement Set allows you to set the cell easily and reliably.

Required accessory

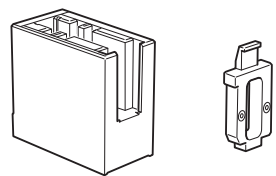
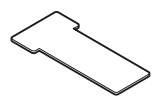
Transmittance Mask ø20 mm CM-A200				Notes Do not touch the inner surface (edge) of the Transmittance Mask with your fingers or wipe it with a cloth to remove dust.
Transmittance Measurement Set CM-A206 (Optional)				
Transmittance Zero Calibration Plate CM-A213	Transmittance Specimen Holder CM-A96	Transmittance Specimen Holder Attachment CM-A199	Accessory Case CM-A193	
				
Cell (Optional)				
Cell: 2 mm CM-A97	Cell: 10 mm CM-A98	Cell: 20 mm CM-A99		
				
Plastic Cell (Optional)				
Plastic Cell: 2 mm CM-A130	Plastic Cell: 10 mm CM-A131	Plastic Cell: 20 mm CM-A132		
				
10 mm Wide Cell Measurement Set CM-A207 (Optional)				
Transmittance Specimen Holder (10 mm wide) CM-A198		Transmittance Zero Calibration Plate (10 mm) CM-A204		
				

Attaching the Transmittance Specimen Holder to the instrument

Notes

- Do not spill a specimen or other liquid on the instrument. Doing so may cause malfunction. If any liquid is spilled on the instrument, wipe it off immediately with a soft, dry cloth.
- Limit the thickness of a specimen to be set on the Transmittance Specimen Holder (optical path length) to 22.5 mm. (The total thickness of the Cell (20 mm) or Plastic Cell (20 mm) and the glass will be 22.5 mm.) Using a specimen or container exceeding this thickness may cause damage.
- To move the position of a specimen after it is set in the Transmittance Specimen Holder, open the specimen fixing plate beforehand to protect the surface of a specimen or the container of a specimen.

1. Open the Transmittance Specimen Chamber Cover.

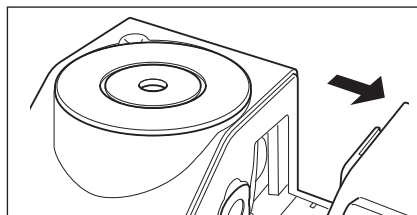

2. As shown in the figure, align the mounting screw of the Transmittance Specimen Holder with the screw hole on the instrument for mounting the holder and tighten the screw with a flat-blade screwdriver.

Memo Although the Transmittance Specimen Holder can be attached facing either the illumination window side or the receiving window side, attach it facing the illumination window side for normal use. In this case, the geometry will be diffuse illumination and 0° viewing angle (di: 0°, de: 0°). If the Transmittance Specimen Holder is attached facing the receiving window side, the geometry is approximately 0°:0° geometry. Although the geometry does not strictly satisfy standards for 0°:0° geometry, this presents no problems if the values are used as relative values.

Memo To attach the holder with the sample or cell on the receiving window side, attach the CM-A199 Transmittance Specimen Holder Attachment before the holder.

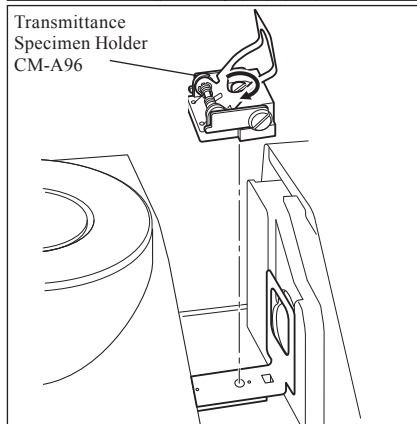
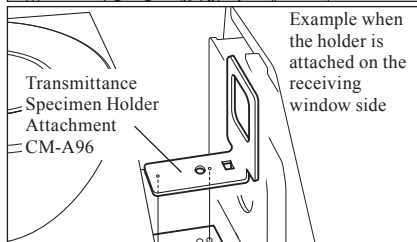
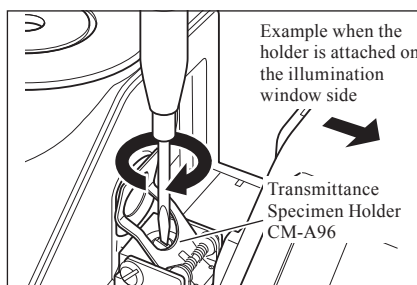

Setting a film specimen

Notes Water drops formed on a specimen due to condensation or other causes prevent accurate measurement.

1. Open the specimen fixing plate and secure a specimen with the plate.

Notes When setting the specimen on the illumination window side, position it so that it fully covers the illumination window. When setting the specimen on the receiving window side, position it so that it fully covers the receiving window.

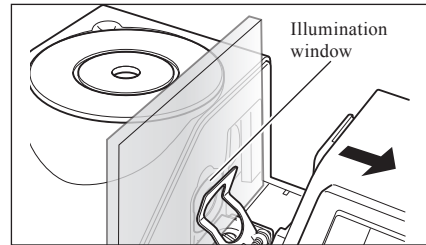

Setting a liquid specimen

- Notes**
- As for the container for a liquid specimen, it is recommended to use the CM-A97 to 99 Cell or CM-A130 to 132 Plastic Cell provided as the optional accessory. To use other containers, use a colorless, transparent container with surfaces which are parallel with the illumination window and receiving window of the instrument.
 - The Cell is fragile and it must be handled with care.
 - Do not pour hot liquid in the Cell or Plastic Cell, and do not wash them with hot water.
 - When cleaning the Cell or Plastic Cell with an ultrasonic cleaner, do not clean them for a long time to prevent damage.
 - The measurement values obtained with cells having different optical path lengths may not be compatible with each other.
 - Do not spill a specimen or other liquid on the instrument. Doing so may cause malfunction. If any liquid is spilled on the instrument, wipe it off immediately with a soft, dry cloth.
 - Do not measure inflammable liquid.
 - Ensure that there are no dust, stains, scratches, or fingerprints on the specimen or on the inner and outer surfaces of the container of a liquid specimen. Set a specimen by holding a section other than the measurement surface to avoid fingerprints.
 - Bubbles in the container containing a liquid specimen prevent accurate measurement. Be sure to remove bubbles before measurement. (Sometimes bubbles may be generated when a specimen is left for a while.)
 - Water drops formed on a specimen or the container containing a liquid specimen due to condensation or other causes prevent accurate measurement.
 - The measurement accuracy for liquid containing fine particles may be unstable due to the deposition of the particles.

Memo When measuring a transparent index such as Gardner, etc., use the Transmittance Specimen Holder (10 mm wide) and a 10 mm-wide cell with an optical path length of 10 mm.

1. Pour a specimen in a transparent container.

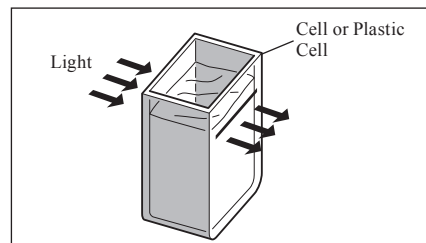

2. Open the specimen fixing plate and secure the container with the plate.

Notes

- When setting the specimen on the illumination window side, position it so that it fully covers the illumination window. When setting the specimen on the receiving window side, position it so that it fully covers the receiving window.
- When using a cell or plastic cell, use the cell guide to determine the center of the cell.

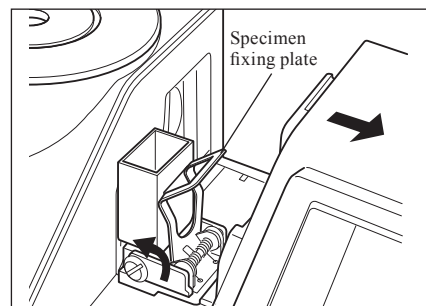

Measuring a liquid specimen by using a commercially-available 10 mm-wide cell

- Notes**
- As for the container for a liquid specimen, use a colorless, transparent container with surfaces which make parallel with the illumination window and receiving window of the instrument.
 - For 10 mm-wide cells, use cells which have an outside width dimension of 12.5 mm. Cells with an outside width of 12 mm cannot be set securely.
 - The measurement values obtained with cells having different optical path lengths may not be compatible with each other.
 - Do not spill a specimen or other liquid on the instrument. Doing so may cause malfunction. If any liquid is spilled on the instrument, wipe it off immediately with a soft, dry cloth.
 - Do not measure inflammable liquid.
 - Ensure that there are no dust, stains, scratches, or fingerprints on the specimen or on the inner and outer surfaces of the container of a liquid specimen. Set a specimen by holding a section other than the measurement surface to avoid fingerprints.
 - Bubbles in the container containing a liquid specimen prevent accurate measurement. Be sure to remove bubbles before measurement. (Sometimes bubbles may be generated when a specimen is left for a while.)
 - Water drops formed on a specimen or the container containing a liquid specimen due to condensation or other causes prevent accurate measurement.
 - The measurement accuracy for liquid containing fine particles may be unstable due to the deposition of the particles.

Memo When measuring a transparent index such as Gardner, etc., use the Transmittance Specimen Holder (10 mm wide) and a 10 mm-wide cell with an optical path length of 10 mm.

1. Open the Transmittance Specimen Chamber Cover.

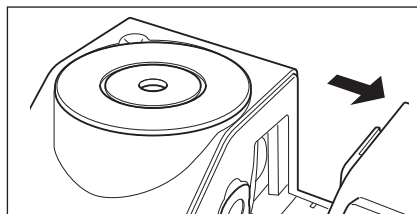

2. As shown in the figure, align the mounting screw of the Transmittance Specimen Holder (10 mm wide) with the screw hole on the instrument for mounting the holder and tighten the screw with a flat-blade screwdriver.

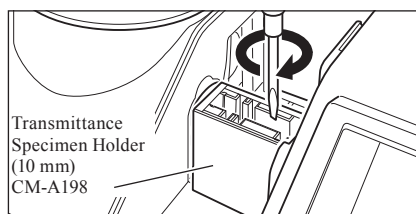

3. Change the position of the cell holding plate to one of the 10 mm, 20 mm or 50 mm groove on the Transmittance Specimen Holder (10 mm wide) according to the optical path length of the cell to be used.

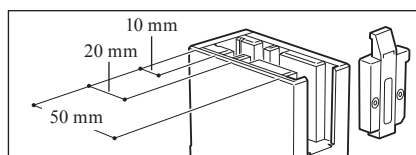

4. Pour a specimen in a transparent, 10 mm-wide container.

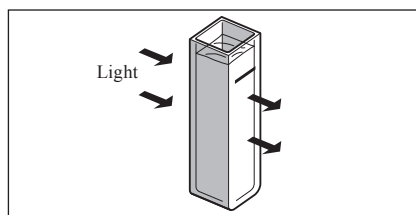

5. Set the container to the Transmittance Specimen Holder (10 mm wide).

- Notes** Be sure to set the cell so that the transparent surfaces of the cell are oriented to the illumination and receiving windows.

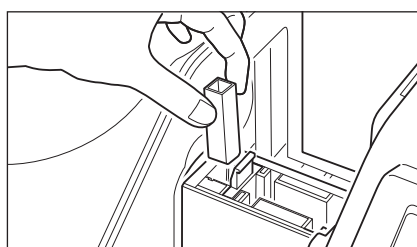

Calibration

Zero Calibration (0% Calibration)

Since the CM-5 stores the data of the zero calibration (0% Calibration) performed at the factory, it is unnecessary to repeat the zero calibration (0% Calibration) every time you turn ON the instrument. If, however, the measurement conditions change greatly, or if the optional Target Mask (ø8 mm or ø3 mm), Petri Dish, Mini Petri Dish, or Cell is used, you need to perform zero calibration (0% Calibration) before white calibration (100% Calibration).

- Memo**
- The effects of stray light (i.e. light generated due to the flare characteristics of the optical system) will be compensated for automatically by the zero calibration (0% Calibration) data.
 - The amount of stray light may change because of dust or dirt which has collected in the optical system, humidity, repeated operation, or vibration and shock exerted on the instrument. In this case, performing zero calibration (0% Calibration) periodically is recommended.

- Notes**
- If the instrument is not used for long periods of time, the zero calibration (0% Calibration) data stored in the instrument may be lost. If the data is lost, zero calibration (0% Calibration) must be performed again.
 - If you performed zero calibration (0% Calibration) using the optional Target Mask (ø8 mm or ø3 mm), Petri Dish or Cell, you must perform zero calibration (0% Calibration) again before conducting measurement using the standard Target Mask.

[Procedure]

Start the procedure from the measurement screen.

Although zero calibration (0% Calibration) is included in the Easy Setup Wizard, the following explains the procedure to perform zero calibration (0% Calibration) from the measurement screen.

1. Press the [CAL] button.

The <Measurement Condition Settings> screen is displayed.

Notes Confirm that the displayed measurement type, measurement area and specular component setting match with conditions of the measurement to be conducted.

Memo The bottom of the <Measurement Condition Settings> screen shows two items: Zero Calibration (0% Calibration) and White Calibration (100% Calibration). The date of the last calibration is displayed for each item. If no calibration has been performed yet, "--" is displayed.

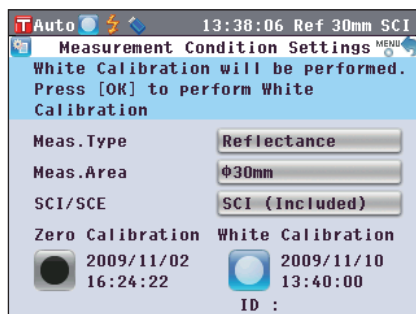

2. Use the or button and the or button of the cross key to move the cursor to Zero Calibration (0% Calibration).

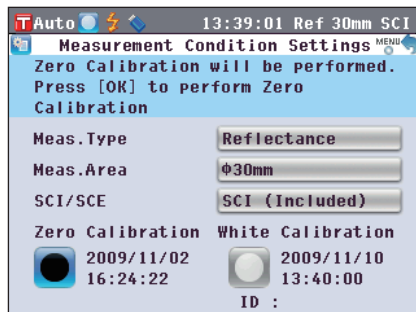

3. Go to the appropriate step according to the measurement type.

<Reflectance measurement> Refer to Steps 3 to 4 (Page 53).

<Reflectance measurement using Petri Dish> Refer to Steps 3 to 5 (Page 53).

<Transmittance measurement> Refer to Steps 3 to 4 (Page 54).

<Liquid transmittance measurement> Refer to Steps 3 to 4 (Page 54).

<Reflectance measurement>

3. Clear an area of 1 m radius from the specimen measuring port of the instrument.

Keep everything including light sources (such as fluorescent lamps and other illumination) and reflective items (hands, desks, walls etc.) more than 1 m away from the specimen measuring port.

Memo Use of the optional Zero Calibration Box CM-A182 ensures proper zero calibration.

4. Press the [OK/Edit] button.

Zero calibration will be performed.

The Xe lamp flashes three times during the calibration. During zero calibration, the screen shows the number of flashes performed.

When the zero calibration is completed, the cursor moves to  White Calibration.

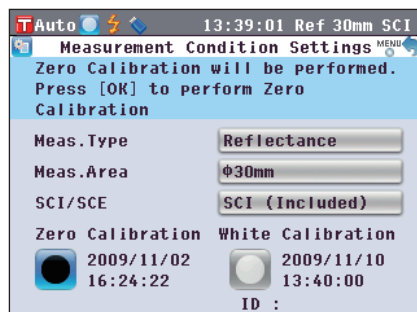
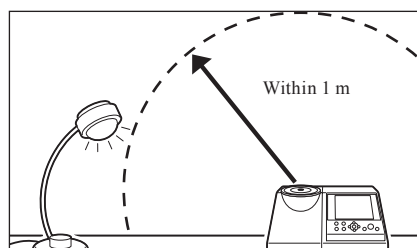

<Reflectance measurement using Petri Dish>

3. Insert the Calibration Glass for Petri Dish into the recess in the Target Mask for Petri Dish.

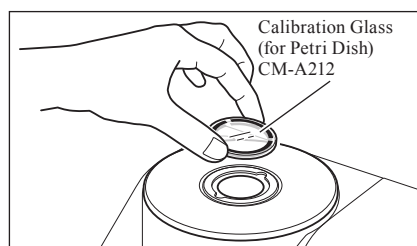

4. Align the Zero Calibration Box with the positioning groove on the Target Mask for Petri Dish and push the box in.

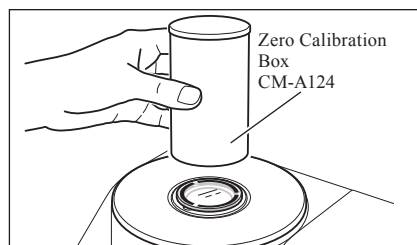

5. Press the [OK/Edit] button.

Zero calibration will be performed.

The Xe lamp flashes three times during the calibration. During zero calibration, the screen shows the number of flashes performed.

When the zero calibration is completed, the cursor moves to  White Calibration.

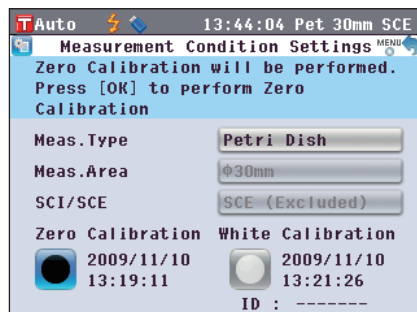

<Transmittance measurement>

3. Open the Transmittance Specimen Chamber Cover and set the Transmittance Zero Calibration Plate so that it fully covers the illumination window.

Notes Set the Transmittance Zero Calibration Plate horizontally, as shown to the right. If the Transmittance Zero Calibration Plate is set vertically, the Transmittance Specimen Chamber Cover may not close.

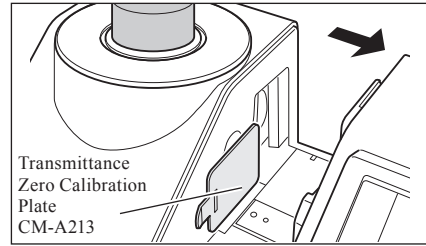

4. Close the Transmittance Specimen Chamber Cover and press the [OK/Edit] button.
0% calibration will be performed.
The Xe lamp flashes three times during the calibration.
During 0% calibration, the screen shows the number of flashes performed.
When the 0% calibration is completed, the cursor moves to 100% Calibration.

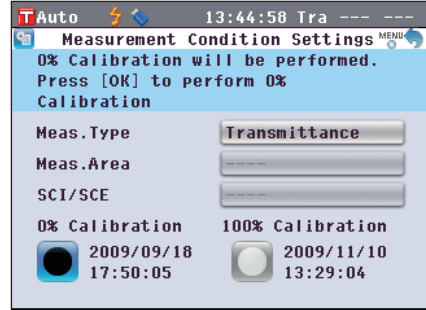

<Liquid transmittance measurement>

3. Open the Transmittance Specimen Chamber Cover and set the Transmittance Zero Calibration Plate so that it fully covers the receiving window. (Refer to the figure for the case of transmittance measurement.)

To use the 10 mm Wide Cell Measurement Set, set the Transmittance Zero Calibration Plate (10 mm) so that it fully covers the receiving window.

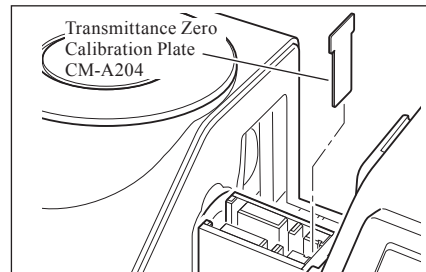

4. Close the Transmittance Specimen Chamber Cover and press the [OK/Edit] button.
0% calibration will be performed.
The Xe lamp flashes three times during the calibration.
During 0% calibration, the screen shows the number of flashes performed.
When the 0% calibration is completed, the cursor moves to 100% Calibration.

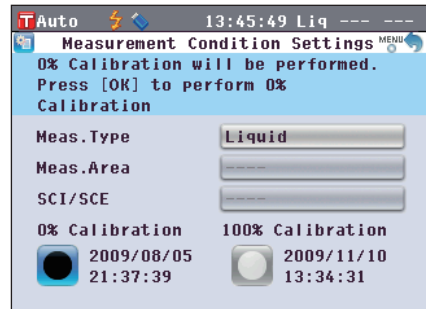

Notes

- After zero calibration (0% Calibration), you need to perform white calibration (100% Calibration). Go to step 3 of “White Calibration (100% Calibration)” on page 55.
- Even though you performed white calibration (100% Calibration) after turning ON the power, you need to perform it again if you performed zero calibration (0% Calibration) after the first white calibration.

White Calibration (100% Calibration)

White calibration (100% Calibration) must be performed prior to start of measurement after the power is turned ON for the first time after purchase at the current settings.

- Memo**
- The built-in White Calibration Plate of the instrument is provided with its own calibration data.
 - When automatic white calibration (100% Calibration) is set to ON, white calibration (100% Calibration) will start automatically when the instrument is turned on.
(Except for liquid measurement or user calibration)
 - The reading may fluctuate slightly due to changes in the ambient temperature or due to heat generation caused by repeated operation of the instrument. In this case, make sure to perform white calibration (100% Calibration) regularly.
- Notes**
- White calibration (100% Calibration) must be performed at the same temperature as the one at which measurement will be performed.
 - Before starting white calibration (100% Calibration), make sure that the instrument is sufficiently acclimatized to the ambient temperature.

[Procedure]

Start the procedure from the measurement screen.

Although white calibration (100% Calibration) is included in the Easy Setup Wizard, the following explains the procedure to perform white calibration (100% Calibration) from the measurement screen.

1. Press the [CAL] button.

The <Measurement Condition Settings> screen is displayed.

Notes Confirm that the displayed measurement type, measurement area and specular component setting match with conditions of the measurement to be conducted.

Memo The bottom of the <Measurement Condition Settings> screen shows two items: Zero Calibration (0% Calibration) and White Calibration (100% Calibration). The date of the last calibration is displayed for each item. If no calibration has been performed yet, "--" is displayed.

2. Use the or button and or button of the cross key to move the cursor to White Calibration (100% calibration).

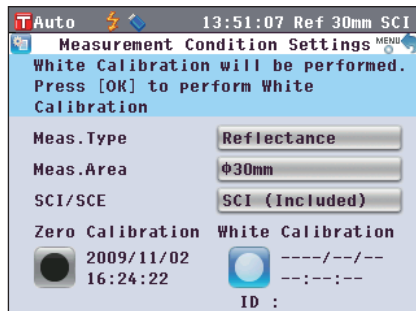
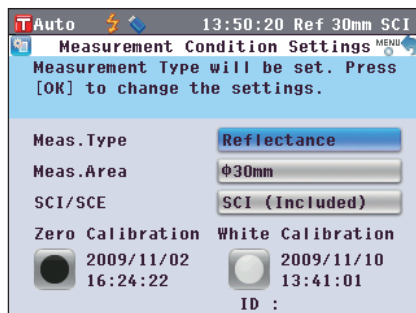

3. Go to the appropriate step according to the measurement type.

<Reflectance measurement>Refer to Step 3 (Page 56).

<Reflectance measurement using Petri Dish>Refer to Steps 3 to 5 (Page 56).

<Transmittance measurement>Refer to Steps 3 to 4 (Page 57).

<Liquid transmittance measurement>Refer to Steps 3 to 4 (Page 57).

<Reflectance measurement>

3. Press the [OK/Edit] button.

White calibration is performed by using the built-in White Calibration Plate of the instrument.

The Xe lamp flashes three times during the calibration. During white calibration, the screen shows the number of flashes performed.

When the white calibration is completed, the screen returns to the one displayed before the <Measurement Condition Settings> screen.

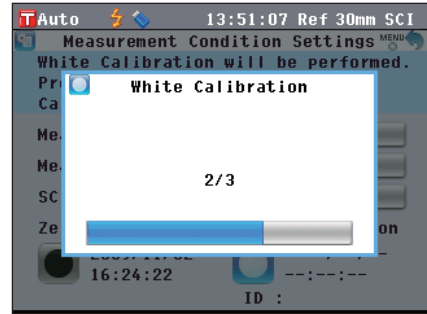

<Reflectance measurement using Petri Dish (1)>

(Using the built-in White Calibration Plate to perform white calibration)

3. Press the [OK/Edit] button.

White calibration is performed by using the built-in White Calibration Plate of the instrument.

The Xe lamp flashes three times during the calibration. During white calibration, the screen shows the number of flashes performed.

When the white calibration is completed, the screen returns to the one displayed before the <Measurement Condition Settings> screen.

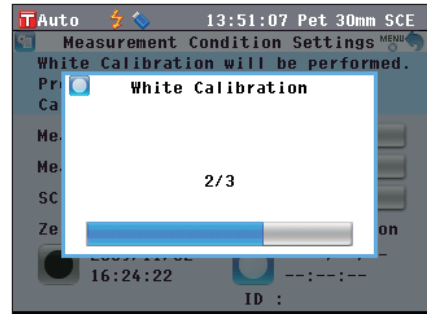

<Reflectance measurement using Petri Dish (2)>

(Using the optional White Calibration Plate to perform white calibration as user calibration)

3. Insert the Calibration Glass for Petri Dish into the recess in the Target Mask for Petri Dish.



4. Align the White Calibration Plate with the positioning groove on the Target Mask for Petri Dish and push the plate in.

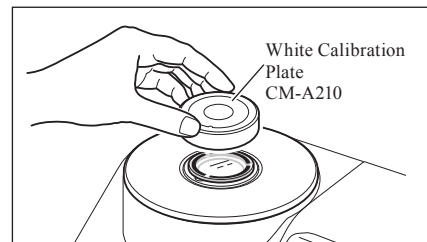

5. Press the [OK/Edit] button.

White calibration will be performed.

The Xe lamp flashes three times during the calibration. During white calibration, the screen shows the number of flashes performed.

When the white calibration is completed, the screen returns to the one displayed before the <Measurement Condition Settings> screen.

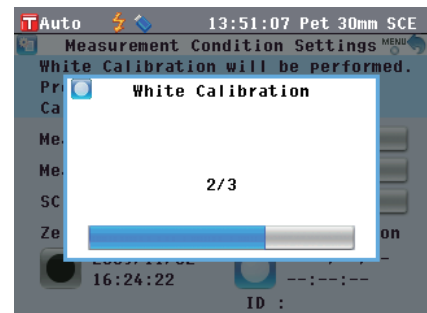

<Transmittance measurement>

3. Open the Transmittance Specimen Chamber Cover and empty the space between the illumination and receiving windows. (No specimen, cell or Zero Calibration Plate being set.)

Notes 100% calibration can be performed with the Transmittance Specimen Holder installed.

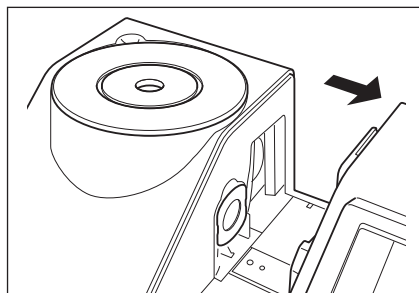

4. Close the Transmittance Specimen Chamber Cover and press the [OK/Edit] button.

100% calibration (air calibration) is performed.

The Xe lamp flashes three times during the calibration.

During 100% calibration, the screen shows the number of flashes performed.

When the 100% calibration is completed, the screen returns to the one displayed before the <Measurement Condition Settings> screen.



<Liquid transmittance measurement>

3. Open the Transmittance Specimen Chamber Cover and set the cell filled with distilled water or purified water to more than two-thirds of the capacity in the Transmittance Specimen Holder.

Notes Be sure to use cells with the same optical path length for the calibration and measurement.

Set the cell so that its transparent surfaces are oriented to the illumination and receiving windows.

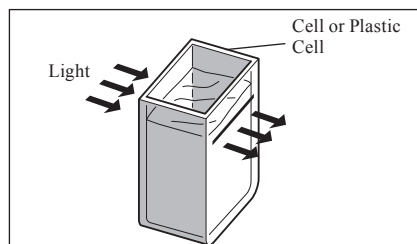

4. Close the Transmittance Specimen Chamber Cover and press the [OK/Edit] button.

100% calibration (distilled water calibration) is performed.

The Xe lamp flashes three times during the calibration.

During 100% calibration, the screen shows the number of flashes performed.

When the 100% calibration is completed, the screen returns to the one displayed before the <Measurement Condition Settings> screen.

Memo If you change the measurement type or other measurement conditions after white calibration (100% calibration), you need to perform white calibration (100% calibration) again under the new conditions.

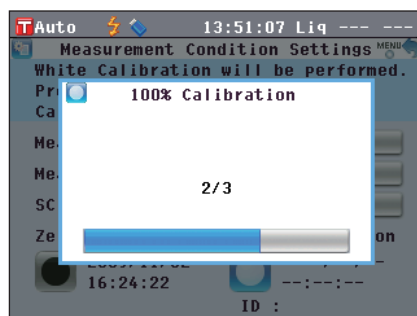

User Calibration

You can perform calibration by using your own reference plate and calibration data instead of the white calibration (100% calibration) data. The calibration data for user calibration can be specified by connecting the instrument to a PC and using the optional Color Management Software “SpectraMagic™ NX”.

You can select whether to use the user calibration data for measurement on the <Calibration Option Setting> screen of the instrument.

[Procedure]

Start the procedure from the measurement screen.

1. Press the [MENU] button.

The <Configuration> screen is displayed.

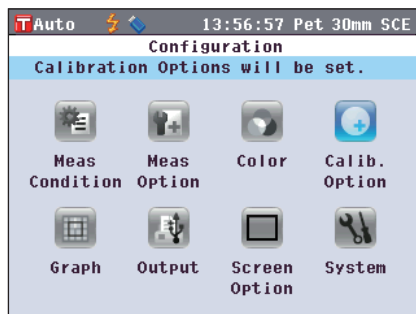

2. Use the or button of the cross key to move the cursor to calibration options and then press the [OK/Edit] button.

The <Calibration Option Settings> screen is displayed.

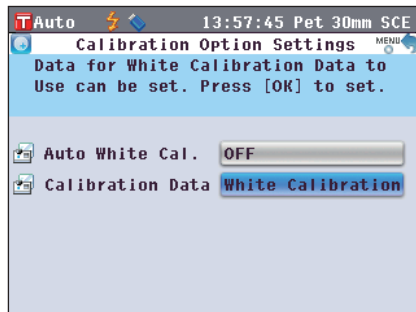

3. Use the or button of the cross key to move the cursor to the desired calibration data and then press the [OK/Edit] button.

The <Calibration Options> screen is displayed.

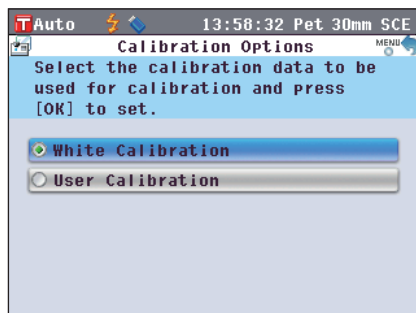

4. Use the or button of the cross key to move the cursor to “User Calibration” and then press the [OK/ Edit] button.

Now you can perform white calibration (100% calibration) using your own calibration data.

Notes You need to prepare user calibration data and write it to the instrument memory before you can set user calibration to ON.

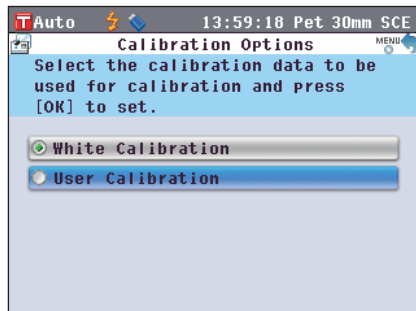

Condition Setting

The CM-5 requires condition settings (measurement condition, measurement option, and color) before measurement can be started.

[Memo] To configure condition settings, select “Meas. Condition” (measurement conditions), “Meas. Option” (measurement options) or “Color” (display conditions) from the <Configuration> screen to open an appropriate screen.

Setting the Measurement Conditions

To set measurement conditions, select “Meas. Condition” from the <Configuration> screen.

You can select or specify the following three items as the measurement conditions:

- Meas. Type: Select the measurement type such as reflectance measurement or transmittance measurement.
- Meas. Area: When the measurement type is reflectance measurement, select an measurement area.
- SCI/SCE: When the measurement type is reflectance measurement, select the specular component mode.

[Setting Procedure]

1. Press the [MENU] button.

The <Configuration> screen is displayed.

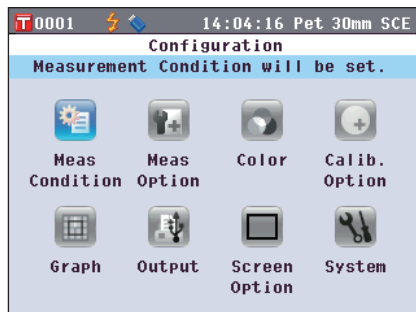

2. Use the ▲ or ▼ button of the cross key to move the cursor to “Meas. Condition” and then press the [OK/ Edit] button.

The <Measurement Condition Settings> screen is displayed.

- The <Measurement Condition Settings> screen shows the current settings.

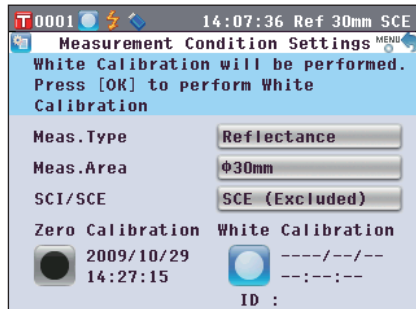

3. After you set the measurement conditions, you can press the [Back] button to return to the screen displayed before you press the [MENU] button in Step 1.

[Memo] To return to the <Configuration> screen, press the [MENU] button.

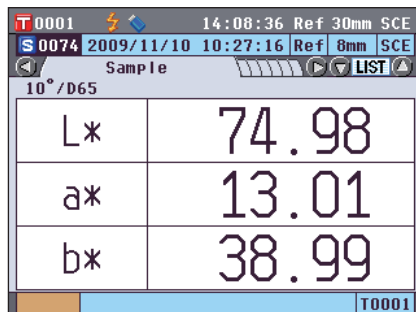

Measurement Type

Select the measurement type such as reflectance measurement or transmittance measurement.

[Setting Procedure]

Start the procedure from the <Measurement Condition Settings> screen.

1. Use the **▲** or **▼** button of the cross key to move the cursor to “Meas. Type” and then press the [OK/Edit] button.
The <Measurement Type Settings> screen is displayed.

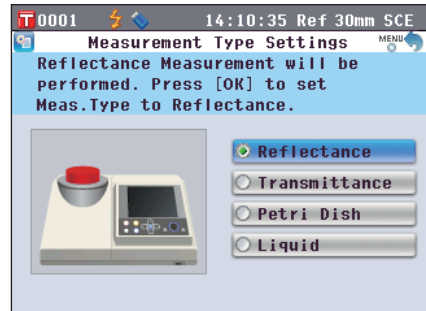

2. Use the **▲** or **▼** button of the cross key to move the cursor to the desired item.
Settings
 - Reflectance: Measure the reflectance of object colors.
 - Transmittance: Measure the transmittance of specimens in the form of plate or film.
 - Petri Dish: Measure the reflectance of powder or paste specimens by using a Petri Dish.
 - Liquid: Measure the transmittance of liquid specimens.

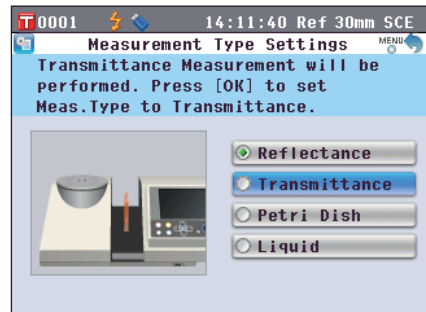

3. Press the [OK/Edit] button.
The selection is confirmed and the screen returns to the <Measurement Condition Settings> screen.

Notes If you press the [Back] button without pressing the [OK/Edit] button, you return to the <Measurement Condition Settings> screen without changing the setting.

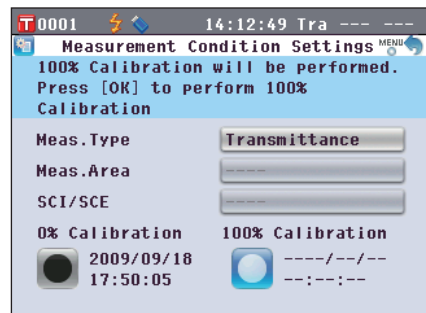



Measurement Area



When the measurement type is Reflectance or Petri Dish, select the measurement area.

[Setting Procedure]

Start the procedure from the <Measurement Condition Settings> screen.

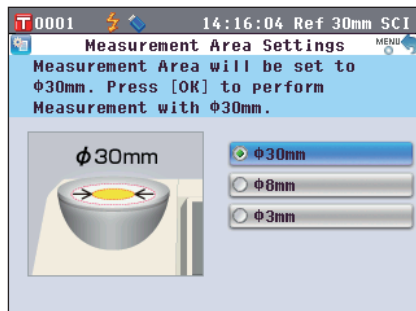
1. Use the  or  button of the cross key to move the cursor to “Meas. Area” and then press the [OK/Edit] button.
The <Measurement Area Settings> screen is displayed.



2. Use the  or  button of the cross key to move the cursor to the desired item.

Settings

- ϕ 30 mm: Measurement area of 30 mm(LAV)
- ϕ 8 mm: Measurement area of 8 mm (MAV); using the optional ϕ 8 mm Target Mask (CM-A195)
- ϕ 3 mm: Measurement area of 3 mm (SAV); using the optional ϕ 3 mm Target Mask (CM-A196)

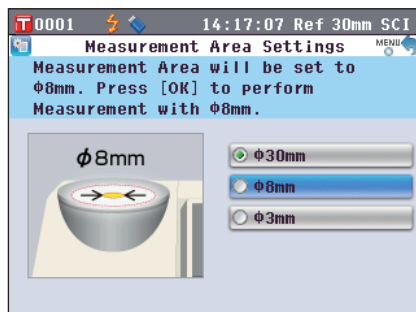

3. Press the [OK/Edit] button.

The selection is confirmed and the screen returns to the <Measurement Condition Settings> screen.

Notes If you press the [Back] button without pressing the [OK/Edit] button, you return to the <Measurement Condition Settings> screen without changing the setting.

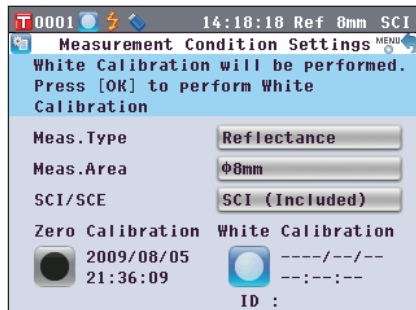



Specular Component (SCI/SCE)



When the measurement type is reflectance measurement, select the specular component mode.
When the Petri Dish measurement is selected, "SCE" is set automatically.

[Setting Procedure]

Start the procedure from the <Measurement Condition Settings> screen.

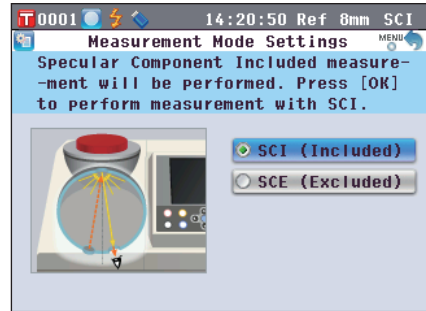
1. Use the  or  button of the cross key to move the cursor to "SCI/SCE" and then press the [OK/Edit] button.
The <Measurement Mode Settings> screen is displayed.



2. Use the  or  button of the cross key to move the cursor to the desired item.
Settings
○ SCI: Specular component included
○ SCE: Specular component excluded

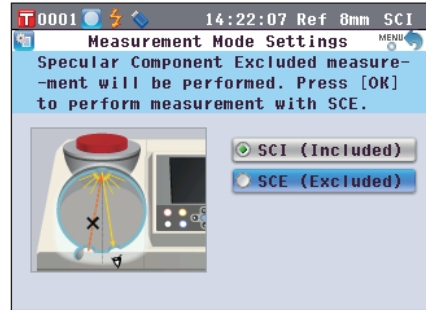

3. Press the [OK/Edit] button.
The selection is confirmed and the screen returns to the <Measurement Condition Settings> screen.

Notes If you press the [Back] button without pressing the [OK/Edit] button, you return to the <Measurement Condition Settings> screen without changing the setting.

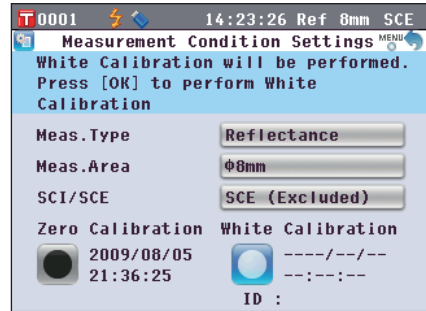

Measurement Option Settings

To set measurement options, select “Measurement Options” from the <Configuration> screen.

You can select or specify the following three items as the measurement options:

- Auto Measurement (1-10): Specify the number of measurements for auto averaging.
- Manual Measurement (1-30): Specify the number of measurements for manual averaging.
- Shutter Open/Close: Open or close the shutter of the specimen measuring port.

[Setting Procedure]

1. Press the [MENU] button.

The <Configuration> screen is displayed.

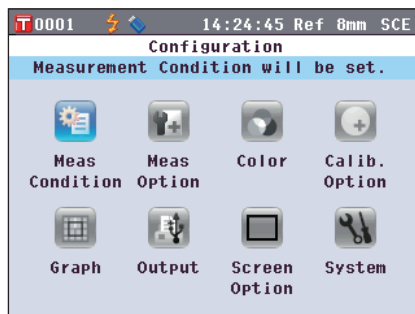

2. Use the ▲ or ▼ button of the cross key to move the cursor to “Meas. Option” and then press the [OK/Edit] button.

The <Measurement Options> screen is displayed.

- The <Measurement Options> screen shows the current settings.

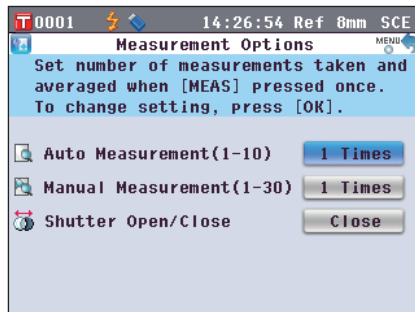

3. After you set the measurement conditions, press the [Back] button to return to the <Configuration> screen.





Auto Measurement (1-10)

Specify the number of measurements for auto averaging.



The average of the data obtained from the specified number of continuous measurements is determined as sample data.

[Setting Procedure]

Start the procedure from the <Measurement Options> screen.

1. Use the  or  button of the cross key to move the cursor to “Auto Measurement (1-10)” and then press the [OK/Edit] button.

Above and below the cursor  and  are displayed.

2. Use the  or  button of the cross key to specify a value.

Settings

○ 1 to 10 times:

Specify the number of measurements, from 1 to 10 times, to perform when using auto averaging.

3. Press the [OK/Edit] button.

The selection is confirmed.

Notes If you press the [Back] button without pressing the [OK/Edit] button, you return to the <Measurement Options> screen without changing the setting.

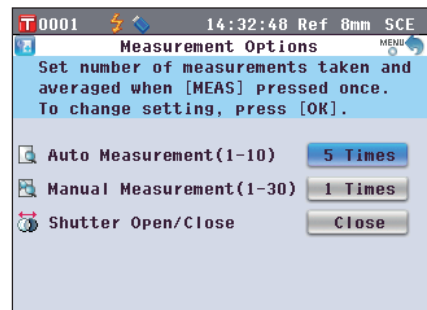
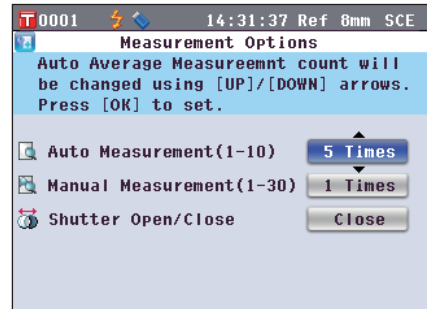
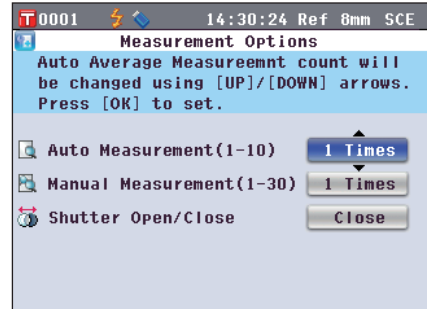

Manual Measurement (1-30)

Specify the number of measurements for manual averaging.

The average of the data obtained from the measurements conducted with the presses of the [MEAS] button for the specified number of times is determined as sample data.

[Setting Procedure]

Start the procedure from the <Measurement Options> screen.

1. Use the ▲ or ▼ button of the cross key to move the cursor to “Manual Measurement (1-30)” and then press the [OK/Edit] button.

Above and below the cursor ▲ and ▼ are displayed.

2. Use the ▲ or ▼ button of the cross key to specify a value.

Settings

○ 1 to 30 times:

Specify the number of measurements, from 1 to 30 times, to perform when using manual averaging.

3. Press the [OK/Edit] button.

The selection is confirmed.

Notes If you press the [Back] button without pressing the [OK/Edit] button, you return to the <Measurement Options> screen without changing the setting.

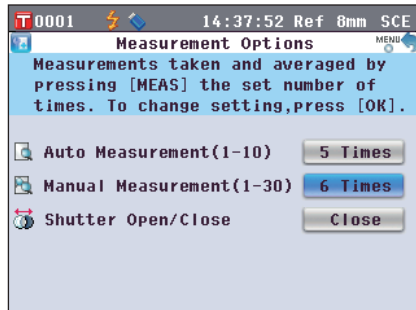
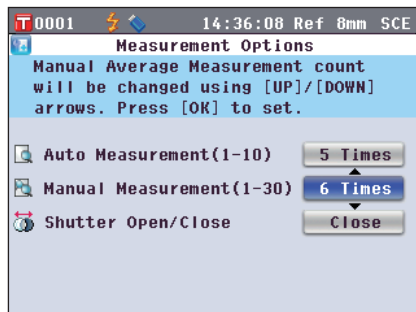
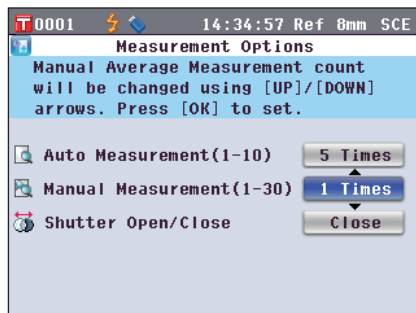



Shutter Open/Close

When cleaning the inside of the integrating sphere or to check the measurement points for a specimen using the Specimen Viewing Mirror (Optional), you need to open or close the shutter of the specimen measuring port. Use this option for the open/close operation.



During measurement, the shutter is automatically opened or closed according to the measurement type.

[Setting Procedure]

Start the procedure from the <Measurement Options> screen.

1. Use the  or  button of the cross key to move the cursor to “Shutter Open/Close” and then press the [OK/Edit] button.

Above and below the cursor  and  are displayed.

2. Use the  or  button of the cross key to specify either to open or close the shutter.

Settings

- Open: Opens the shutter
- Close: Closes the shutter

3. Press the [OK/Edit] button.

The shutter opens or closes according to the selection.

Notes If you press the [Back] button without pressing the [OK/Edit] button, you return to the <Measurement Options> screen without changing the setting.

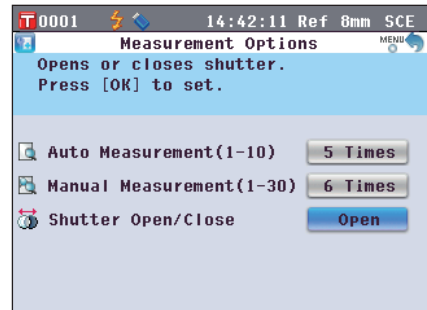
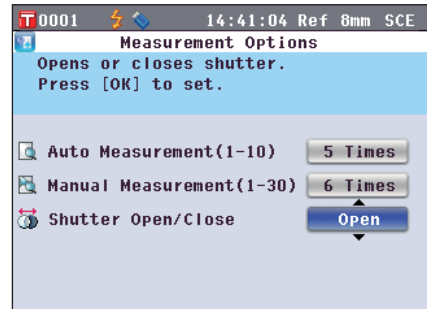
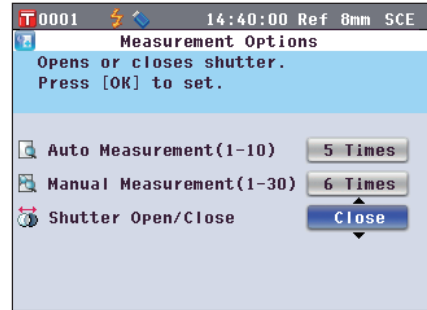

Memo For the transmittance measurement, the geometry will be set to $di:0^\circ$ when the shutter is closed and will be set to $de:0^\circ$ when the shutter is open and the Zero Calibration Box is set.

In the haze measurement, the optional Color Management Software SpectraMagic™ NX (CM-S100w) allows haze calculation after automatic selection of the geometry (shutter open/close).

Setting the Display Conditions

To set display conditions, select “Color” from the <Configuration> screen.

You can select or specify the following five items as the display conditions:

- Color Space: Select the color space to be displayed.
- Color Index: Select the index (WI, YI, etc.) to display.
- Observer: Select the observer angle: 2° or 10°.
- Illuminant 1: Select the illuminant used to measure colorimetric data.
- Illuminant 2: Select the secondary illuminant used for MI (metamerism index) calculation, etc.

[Setting Procedure]

1. Press the [MENU] button.

The <Configuration> screen is displayed.



2. Use the ▲ or ▼ button of the cross key to move the cursor to “Color” and then press the [OK/Edit] button.

The <Color Settings> screen is displayed.

- The <Color Settings> screen shows the current settings.



3. After you set the display conditions, press the [Back] button to return to the <Configuration> screen.





Color Space

Select the color space to be used or the index used for transmittance measurement.



[Setting Procedure]



Start the procedure from the <Color Settings> screen.

1. Use the  or  button of the cross key to move the cursor to the desired “Color Space” and then press the [OK/Edit] button.

The <Color Space Settings> screen is displayed.



2. Use the  or  button of the cross key to move the cursor to the desired item.

- Use the  or  button of the cross key to move the cursor to the digit on the left or right.

Settings

- L*a*b*: L*a*b* color space
- L*C*h: L*C*h color space
- Hunter Lab: Hunter Lab color space
- Yxy: Yxy color space
- XYZ: XYZ color space
- Munsell (C): Munsell color space (illuminant “C”)
- Munsell (D65): Munsell color space (illuminant “D65”)
- Gardner: Transparent index, Gardner
- Hazen/APHA: Transparent index, Platinum-Cobalt Color scale (Hazen/APHA)
- Iodine Color Value: Transparent index, Iodine color scale
- Ph. EU: European Transparent index, Pharmacopoeia
- US Pharmacopeia: Transparent index, US Pharmacopoeia

Memo

- A value for Munsell (C) is displayed only when observer 2° and illuminant “C” are selected.
- A value for Munsell (D65) is displayed only when observer 2° and illuminant “D65” are selected.
- A value for Gardner is displayed only when observer 2° and illuminant “C” are selected.
- A value for Hazen/APHA is displayed only when observer 2° and illuminant “C” are selected.
- A value for Iodine is displayed only when observer 2° and illuminant “C” are selected.
- A value for Ph. EU is displayed only when observer 2° and illuminant “C” are selected.
- A value for US Pharmacopeia is displayed only when observer 2° and illuminant “C” are selected.



3. Press the [OK/Edit] button.

If you select L*a*b* or L*C*h, <Difference Formula Settings> screen is displayed.

If you select Ph. EU, <Ph.EU Hue setting> screen is displayed.

If you select options other than above, the selection is confirmed and the screen returns to the <Color Settings> screen.

Notes If you press the [Back] button without pressing the [OK/Edit] button, you return to the <Color Settings> screen without changing the setting.

4. If you select L*a*b*, L*C*h or Ph. EU, use the \uparrow or \downarrow button of the cross key to move the cursor to the desired item.

Settings (When L*a*b* or L*C*h is selected)

- ΔE^*ab : ΔE^*ab (CIE1976) color difference formula
- CMC: CMC color difference formula; parameters can be changed.
- ΔE^*94 : ΔE^*94 (CIE1994) color difference formula; parameters can be changed.
- $\Delta E00$: $\Delta E00$ (CIE DE2000) color difference formula; parameters can be changed.

Settings (When Ph. EU is selected)

- Auto: Automatic
- B: Brown
- BY: Brownish-Yellow
- Y: Yellow
- GY: Greenish-Yellow
- R: Red

5. Press the [OK/Edit] button.

The selection is confirmed and the screen returns to the <Color Settings> screen.

Notes If you press the [Back] button without pressing the [OK/Edit] button, you return to the <Color Space> screen without changing the setting.

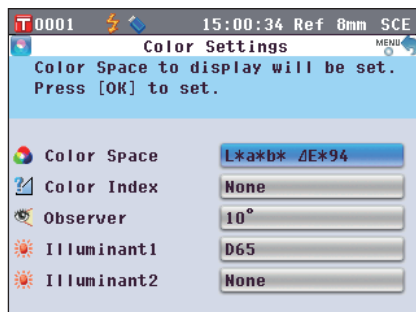
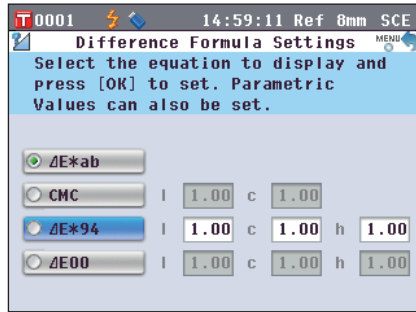
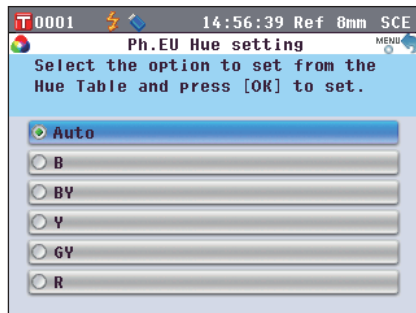



Color Index

Select the index (WI, YI, etc.) to be used.

This screen is available when the user index has been set with the optional Color Management Software SpectraMagic™ NX (CM-S100w) in advance.

[Setting Procedure]



Start the procedure from the <Color Settings> screen.

1. Use the  or  button of the cross key to move the cursor to “Color Index” and then press the [OK/Edit] button.

The <Color Index> screen is displayed.

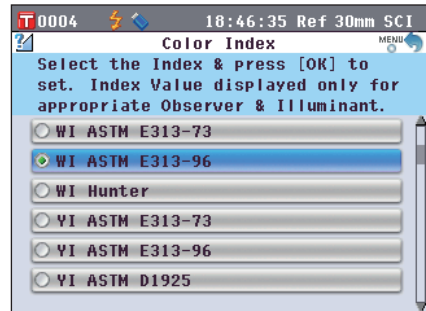
A scroll bar to the right of the <Color Index> screen, signifies that some color indexes cannot be displayed on the screen.



2. Use the  or  button of the cross key to move the cursor to the desired item.

Settings

Move the cursor up from the top of the list, or down from the bottom of the list, to display those indexes that cannot be displayed on the screen.

- WI ASTM E313-73: Whiteness index (ASTM E313-73)
- WI ASTM E313-96: Whiteness index (ASTM E313-96)
- WI Hunter: Whiteness index (Hunter)
- YI ASTM E313-73: Yellowness index (ASTM E313-73)
- YI ASTM E313-96: Yellowness index (ASTM E313-96)
- YI ASTM D1925: Yellowness index (ASTM D1925)
- B ASTM E313-73
- ISO Brightness
- None

Memo

- A value for WI ASTM E313-73 is displayed only when observer 2° and illuminant “C” are selected.
- A value for WI ASTM E313-96 is displayed only when illuminant “C”, “D50” or “D65” is selected.
- A value for WI Hunter is displayed only observer 2° and illuminant “C” are selected.
- A value for YI ASTM E313-73 is displayed only when observer 2° and illuminant “C” are selected.
- A value for YI ASTM E313-96 is displayed only when illuminant “C”/“D65” are selected.
- A value for YI YI D1925 is displayed only when illuminant “C” is selected.
- A value for B ASTM E313-73 is displayed only when observer 2° and illuminant “C” are selected.

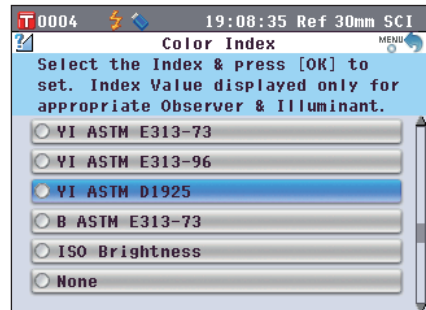

3. Press the [OK/Edit] button.

The selection is confirmed and the screen returns to the <Color Settings> screen.

Notes If you press the [Back] button without pressing the [OK/Edit] button, you return to the <Color Settings> screen without changing the setting.





Observer

Select the observer angle: 2° or 10°.



[Setting Procedure]

Start the procedure from the <Color Settings> screen.

1. Use the  or  button of the cross key to move the cursor to the desired “Observer” and then press the [OK/Edit] button.

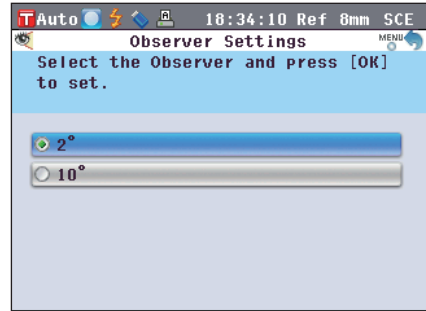
The <Observer Settings> screen is displayed.



2. Use the  or  button of the cross key to move the cursor to the desired item.

Settings

- 2°: 2° observer (CIE1931)
- 10°: 10° observer (CIE1964)

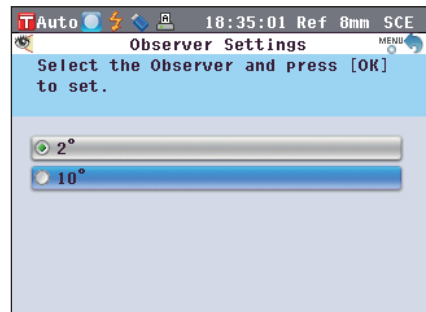

3. Press the [OK/Edit] button.

The selection is confirmed and the screen returns to the <Color Settings> screen.

Notes If you press the [Back] button without pressing the [OK/EDIT] button, you return to the <Color Settings> screen without changing the setting.





Illuminant 1



Select the illuminant used to measure colorimetric data.

[Setting Procedure]

Start the procedure from the <Color Settings> screen.

1. Use the  or  button of the cross key to move the cursor to the desired “Illuminant 1” and then press the [OK/Edit] button.

The <Primary Illuminant> screen is displayed.

2. Use the  or  button of the cross key to move the cursor to the desired item.

Settings

- A Standard illuminant A (Incandescent lamp, Color temperature: 2856K)
- C Illuminant C; (Daylight, The relative value of the spectral distribution in the ultraviolet region is small; Color temperature: 6774K)
- D65 Standard illuminant D65 (Daylight, Color temperature: 6504K)
- D50 Standard illuminant D50 (Daylight, Color temperature: 5003K)
- ID65 Indoor daylight illuminant ID65 (Daylight after passing through window glass, Color temperature: 6504K)
- ID50 Indoor daylight illuminant ID50 (Daylight after passing through window glass, Color temperature: 5003K)
- F2 Cool white (fluorescent lamp)
- F6 Cool white (fluorescent lamp)
- F7 Color rendering A daylight white (fluorescent lamp)
- F8 Color rendering AAA natural white (fluorescent lamp)
- F10 3-band type natural white (fluorescent lamp)
- F11 3-band type cool white (fluorescent lamp)
- F12 3-band type warm white (fluorescent lamp)

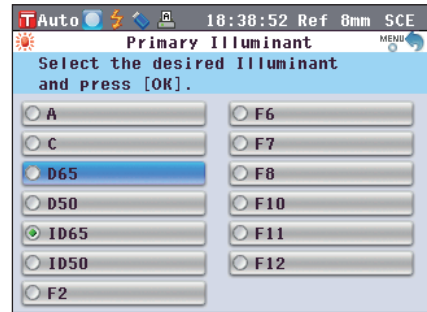
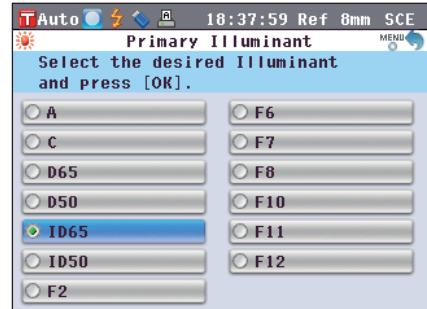

3. Press the [OK/Edit] button.

The selection is confirmed and the screen returns to the <Color Settings> screen.

Notes If you press the [Back] button without pressing the [OK/Edit] button, you return to the <Color Settings> screen without changing the setting.





Illuminant 2



Select the secondary illuminant used for MI (metamerism index) calculation, etc.

[Setting Procedure]

Start the procedure from the <Color Settings> screen.

1. Use the  or  button of the cross key to move the cursor to the desired “Illuminant 2” and then press the [OK/Edit] button.

The <Secondary Illuminant> screen is displayed.

2. Use the  or  button of the cross key to move the cursor to the desired item.

Settings

- The setting values are the same as those for “Illuminant 1” and “None”.

3. Press the [OK/Edit] button.

The selection is confirmed and the screen returns to the <Color Settings> screen.

Notes If you press the [Back] button without pressing the [OK/EDIT] button, you return to the <Color Settings> screen without changing the setting.

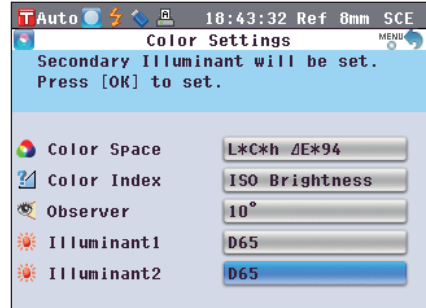
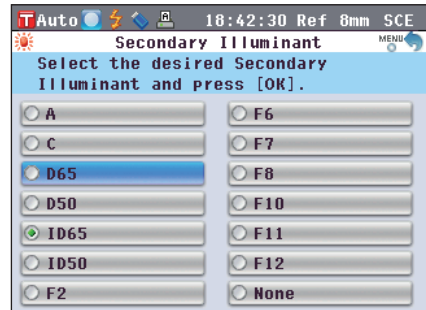
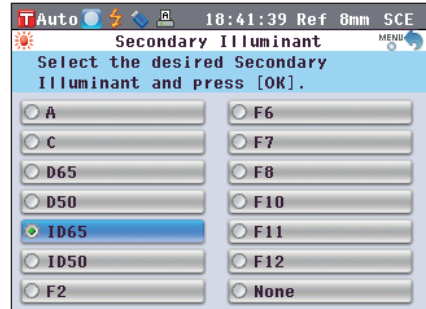

Color Difference Target Color Data Operation

Settings

To measure the color difference between two specimens, the color of one of the specimens must be set as the target color. The CM-5 can store up to 1,000 target colors.

When using the instrument alone, measure a target specimen by following the procedure below and set the result as the target color.

- Memo**
- Target colors are stored with setting numbers from 0001 to 1000 being assigned. Even when the data at some midpoint is deleted, these setting numbers do not change. It is useful to group data by assigning numbers of specific digits.
 - To set more accurate target color data, use averaging to measure the target specimen. For details, refer to "Average Measurement" on page 134.

- Notes**
- Be sure to perform white calibration before setting target colors.
 - To ensure measurement accuracy, make sure to keep ambient conditions (temperature, etc.) constant.

[Setting Procedure]

1. From the <Sample> screen, press the [Target/Sample] button.

The <Target> screen is displayed.

- Pressing the [Detail/List] button switches between the <Target> screen and <Target List> screen.

Target	
L*	73.95
C*	76.83
h	74.23

2. Use the ▲ or ▼ button of the cross key to move to a desired target color No.

Notes Unlike measured data, the numbers assigned to target color data do not change automatically. When you measure colors continuously to set target colors, you need to move the cursor manually to set each data.

Target No.	Date	Time	Ref	SCE
T0001	2009/10/02	14:05:51	Ref 30mm	SCE
T0002	2009/09/16	10:36:05	Ref 30mm	SCE
T0003	2009/09/17	13:46:55	Ref 30mm	SCE
T0004	2009/11/08	07:14:29	Ref 8mm	SCI
T0005	2009/09/16	16:12:20	Tra	---
T0006	2009/09/16	16:45:38	Tra	---

3. Place a specimen on the Target Mask or Transmittance Specimen Chamber according to the measurement type.

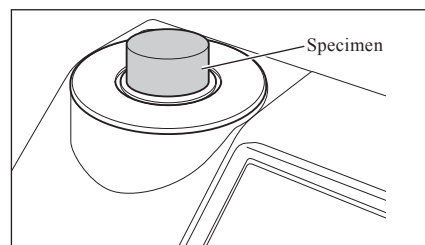

4. Make sure that  (Ready to measure) is displayed or the Ready lamp is green, and then press the measuring button.

The specimen is measured and the result is displayed on the screen.

Notes If you selected a number to which target color data has already been set, a message is displayed to confirm overwriting.

5. To set more target colors, repeat steps 2 to 4.

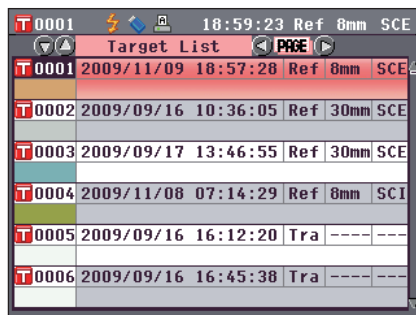

T	0001	2009/11/09	18:57:28	Ref	8mm	SCE
T	0002	2009/09/16	10:36:05	Ref	30mm	SCE
T	0003	2009/09/17	13:46:55	Ref	30mm	SCE
T	0004	2009/11/08	07:14:29	Ref	8mm	SCI
T	0005	2009/09/16	16:12:20	Tra	----	---
T	0006	2009/09/16	16:45:38	Tra	----	---

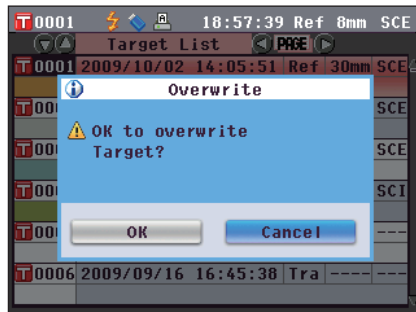

T	0001	2009/10/02	14:05:51	Ref	30mm	SCE
T	0001	2009/10/02	14:05:51 <td>Ref</td> <td>30mm</td> <td>SCE</td>	Ref	30mm	SCE
T	0001	2009/10/02	14:05:51 <td>Ref</td> <td>30mm</td> <td>SCE</td>	Ref	30mm	SCE
T	0001	2009/10/02	14:05:51 <td>Ref</td> <td>30mm</td> <td>SCE</td>	Ref	30mm	SCE
T	0001	2009/10/02	14:05:51 <td>Ref</td> <td>30mm</td> <td>SCI</td>	Ref	30mm	SCI
T	0001	2009/10/02	14:05:51 <td>Ref</td> <td>30mm</td> <td>---</td>	Ref	30mm	---
T	0006	2009/09/16	16:45:38	Tra	----	---

Editing Target Color Data

The <Target Data Function> screen allows the following operations for target color data.

“Current” tab

- Save: Saves the current target color data to a USB memory device.
- Statistics: Performs statistical calculations using multiple target color data selected in a list screen.
- Edit Name: Name the target color data.
- Print: Print the target color data.
- Tolerance: Specify the tolerance (box tolerance) used for pass/fail judgment of measured data.
- Delete: Delete the target color data.

“All” tab

- Save: Save all target color data to the USB memory device. This option can be selected only when a USB memory device has been connected.
- Tolerance: (Def) Before setting tolerance for individual target color data, set default tolerance to be applied to all target color data in common.
- Data Protect: Disable the deletion or editing of the target color data. When the data protection is set, you cannot select “Edit Name”, “Tolerance”, “Delete” and “Delete All” on the <Target Data Function> screen.
- Delete All: Delete all target color data when the data protection is not set.

[Setting Procedure]

1. On the <Target> screen, press the [OK/Edit] button.
The <Target Data Function> screen is displayed.

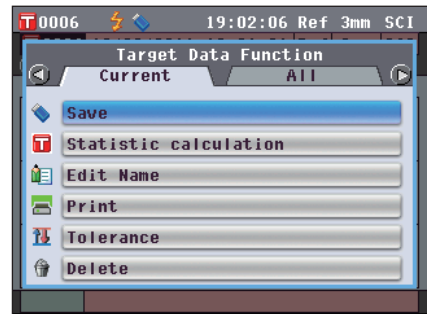

2. Use the ◀ or ▶ button of the cross key to select the tab, use the ▲ or ▼ button to move the cursor to the desired item to set or start, and then press the [OK/Edit] button.
The setting screen for the selected item is displayed.
For the setting procedure of each item, refer to the following sections.



3. On the <Target Data Function> screen, press the [Back] button to return to the <Target> screen.

Target	
L*	74.90
C*	40.62
h	71.80

Saving the Current Target Color Data to a USB Memory Device

Save the current target color data to a USB memory device.

You will need to connect a USB memory device to the instrument in advance. For information on connecting a USB memory device, refer to page 141 “Connecting a USB Memory”.

[Operating Procedure]

Start the procedure from the <Target Data Function> screen

1. Use the ◀ or ▶ button of the cross key to select the “Current” tab, use the ▲ or ▼ button to move the cursor to “Save”, and then press the [OK/Edit] button.

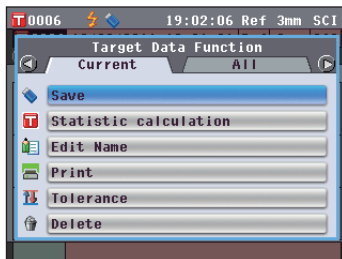

2. The <Save Target Data> screen is displayed with a suggested file name shown.

To change the file name, use the ▲ and ▼ button of the cross key to move the cursor to the current file name and then press the [OK/Edit] button.



3. The <Edit File Name > screen is displayed.

Use the ◀ or ▶ and ▲ or ▼ buttons of the cross key to move the cursor around the characters and then press the [OK/Edit] button.

The selected character is added to the text box.

To change a file name using the USB keyboard, remove the USB memory device while on the name editing screen, and input the name after connecting the USB keyboard.

4. Repeat Step 3 until you have entered the necessary characters.

- The position where characters will be added can be changed by using the ▲ or ▼ button of the cross key to position the cursor in the text box. The file name will then be modified at the position of the cursor.
- To delete the character to the left of the cursor in the text box, press the [CAL] button.
- The file name can be up to 20 characters long.

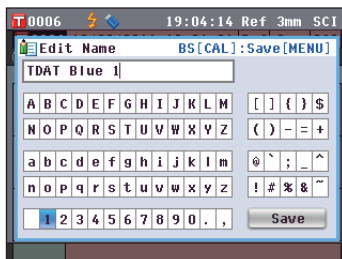

Memo

A USB keyboard can also be used to input file names. For information on connecting a USB keyboard, refer to page 143 “Connecting a USB Keyboard”.

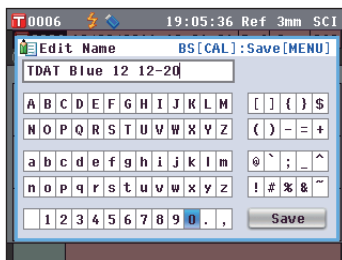

- When you are finished entering characters, press [MENU] button, move the cursor to “Save” and then press the [OK/Edit] button.

The settings are confirmed and the screen returns to the <Save Target Data> screen.

Memo If you press the [Back] button during the setting, “Do you want to save the changes?” is displayed. If you then place the cursor on “OK” and press the [OK/Edit] button, the setting details are confirmed and the screen returns to the <Save Target Data> screen; if you place the cursor on “Cancel” and press the [OK/Edit] button, the setting details are not changed and the screen returns to the <Save Target Data> screen.

- Verify that a USB memory device is connected. To accept the displayed file name, use the ▲ or ▼ button of the cross key to move the cursor to  and then press the [OK/Edit] button. The <Saving...> screen is displayed.

When the saving is complete, the screen returns to the <Target> detail screen.

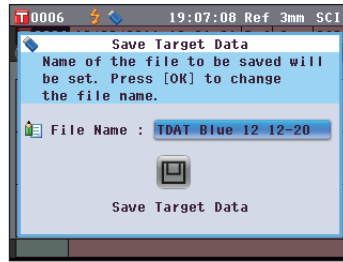

Memo

The USB memory device must be connected to the instrument before saving the condition file to a USB memory device. For information on connecting a USB memory device, refer to page 141 “Connecting a USB Memory”.

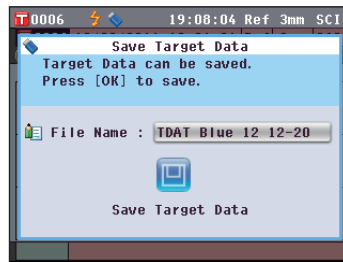

Performing Statistical Calculations on Target Data

Performs statistical data on target data stored in the instrument. The data to be used for calculations can be selected in a list screen. After calculations have been performed, the average of the targets selected for statistical calculations can be saved.

To save the average as a new target data, be sure to select a target color No. for which no data has been set before proceeding. If this procedure is performed when a target color No. which already contains target color data, the existing target color data will be overwritten when save is performed.

- Use the ◀ or ▶ button of the cross key to select the “Current” tab, use the ▲ or ▼ button to move the cursor to “Statistic calculation”, and then press the [OK/Edit] button.

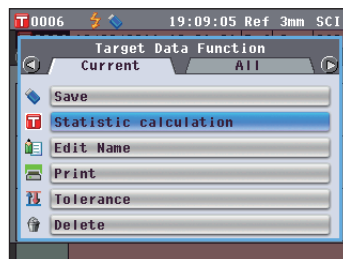

2. The <Target List> screen will appear.



3. Use the **▲** or **▼** button of the cross key to select a target to use for statistical calculations and then press the **[OK/Edit]** button to confirm the selection.

- A check mark will appear in the box to the left of the target name when a target is selected.
- Statistics can be performed using only targets measured under the same measurement conditions (measurement type, measurement area, SCI/SCE setting).
- To deselect a target with a check mark, move the cursor to the target and then press the **[OK/Edit]** button again.
- To select all targets shown on the screen, use the **▲** or **▼** button of the cross key to move the cursor to the "Page" button and then press the **[OK/Edit]** button. Check marks will appear to the left of all targets shown.
- Use the **◀** or **▶** button of the cross key to move to other pages in instrument memory. Selected data will remain selected even if pages are changed.



4. After all desired targets have been selected, use the **▲** or **▼** button of the cross key to move the cursor to the “OK” button and then press the [OK/Edit] button.

The <Statistic calculation> screen will appear.

- To save the average of the data, use the **▲** or **▼** button of the cross key to move the cursor to the [Save] button and press the [OK/Edit] button. If data already exist for the currently selected target color No., an overwrite confirmation message will appear. The data will be saved under the name “Averaged” and the <Statistic calculation> screen will close.
- To exit the <Statistic calculation> screen without saving, use the **▲** or **▼** button of the cross key to move the cursor to the [Cancel] button and press the [OK/Edit] button. The screen will return to the <Target List> screen.



The screenshot shows a window titled "Statistic calculation" with a measurement count of 4. It contains a table with the following data:

	L*	a*	b*
Avg.	81.60	-8.47	12.73
Max.	85.66	-7.08	13.96
Min.	70.52	-9.00	9.58
S. D.	7.17	0.90	2.02

At the bottom of the screen, there are two buttons: "Save" and "Cancel".

Edit Name

Name the target color data.

[Procedure]

Start the procedure from the <Target Data Function> screen.

1. Use the ◀ or ▶ button of the cross key to select the “Current” tab, use the ▲ or ▼ button to move the cursor to “Edit Name”, and then press the [OK/Edit] button.

The <Edit Name> screen is displayed.

Memo A USB keyboard can also be used to input file names. For information on connecting a USB keyboard, refer to page 143 “Connecting a USB Keyboard”.

2. Use the ◀ and ▶ or ▲ and ▼ buttons of the cross key to move the cursor around the characters and then press the [OK/Edit] button.

- Up to 20 characters can be used.
- The selected character is displayed in the text box.

3. Repeat Step 2 until you have entered the necessary characters.

- You can use the ▲ or ▼ button of the cross key to move the blue box cursor on the text box.
In this status, you can move the character position and modify the character by pressing the ◀ or ▶ button of the cross key.
- To delete the character to the left of the cursor in the text box, press the [CAL] button.

4. When you are finished entering characters, use the ◀ and ▶ or ▲ and ▼ buttons of the cross key to move the cursor to “Save” and then press the [OK/Edit] button.
The setting is confirmed and the screen returns to the <Target> screen.

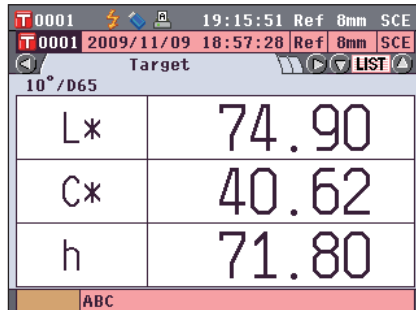
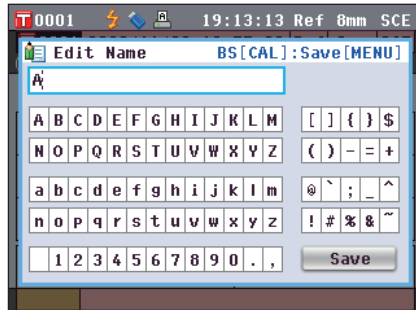
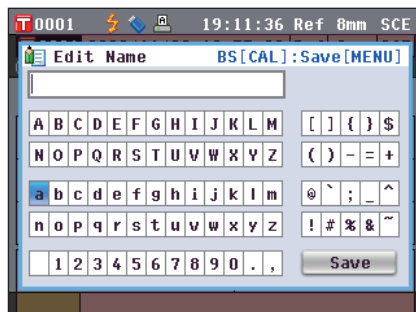

Memo

If you press the **[Back]** button during the setting, “Do you want to save the changes?” is displayed. When you place the cursor on “OK” and press the **[OK/Edit]** button, the setting details are confirmed and the screen returns to the **<Target>** screen. When you place the cursor on “Cancel” and press the **[OK/Edit]** button, the setting details are not changed and the screen returns to the **<Target Data Functions>** screen.



Print

Print the target color data.

You need to connect the instrument to a serial printer in advance. For the connection of the instrument and a serial printer, refer to “Printer Connection” (Page 145).

Notes

- If the connection is not established properly, printing is disabled.
- Even if the connection has been correctly established, printing may fail for reasons such as the printer is turned off when printing is attempted.

[Procedure]

Start the procedure from the **<Target Data Function>** screen.

1. Use the **◀** or **▶** button of the cross key to select the “Current” tab, and use the **▲** or **▼** button to move the cursor to “Print”.

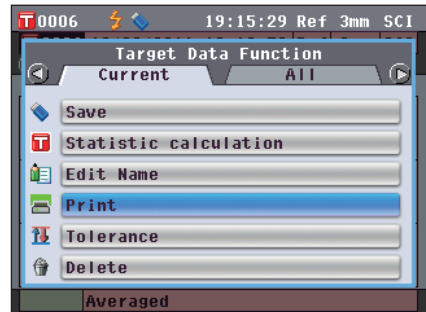

2. Press the **[OK/Edit]** button. The **<Print Target Data>** screen is displayed and the data is printed from the connected printer.

- When the printing is complete, the screen returns to the **<Target>** screen.

Notes

The **<Print Target Data>** screen is also displayed for the case where printing will not be processed properly such as when the printer connection is incorrect.

Tolerance Setting

Specify the tolerance used for pass/fail judgment of measured data for each target color.

- Memo**
- Before tolerance is specified for individual target colors, the instrument is set with default tolerance. For details, refer to page 89 “Default Tolerance Setting”.
 - The tolerance setting items are the same as those for the color space or index currently selected for the display conditions.
 - With the optional Color Management Software “SpectraMagic™ NX”, you can set or use the color difference tolerance easily.

[Setting Procedure]

Start the procedure from the <Target Data Functions> screen.

1. Use the \leftarrow or \rightarrow button of the cross key to select the “Current” tab, use the \uparrow or \downarrow button to move the cursor to “Tolerance”, and then press the [OK/Edit] button.

The <Tolerance> screen is displayed.



2. Use \leftarrow and \rightarrow or the \uparrow and \downarrow button of the cross key to move the cursor to the desired item.



3. Press the [OK/Edit] button to change the details.

- When the selected item is not currently checked, pressing the [OK/Edit] button causes the item to be checked, and you can change the setting value.
- When the selected item is not currently checked, pressing the [OK/Edit] button causes the item to be checked. Press the \rightarrow button of the cross key to move the blue box cursor to the setting value area. When you press the [OK/Edit] button, the cursor appears on the value. Press the \uparrow or \downarrow button of the cross key to change the value.

Memo You can move the cursor between the digits of the value by pressing the \leftarrow or \rightarrow button of the cross key.



Settings

○0.1 to 20.0

* Settings of x and y are 0.001 to 0.200.

- You need to press the [OK/Edit] button to confirm the change every time you change the setting of an item.

4. When you finish all settings, press the **▶** button or **[MENU]** button of the cross key to move the cursor on “Save”, and then press the **[OK/Edit]** button. The setting is confirmed and the screen returns to the **<Target Data Function>** screen.

[Memo] If you press the **[Back]** button during the setting, the **<Save Confirmation>** screen is displayed. When you place the cursor on “OK” and press the **[OK/Edit]** button, the setting details are confirmed. When you place the cursor on “Cancel” and press the **[OK/Edit]** button, the setting details are not changed. After that, the screen returns to the **<Target Data Function>** screen.

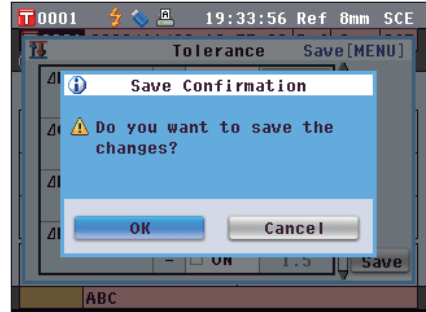
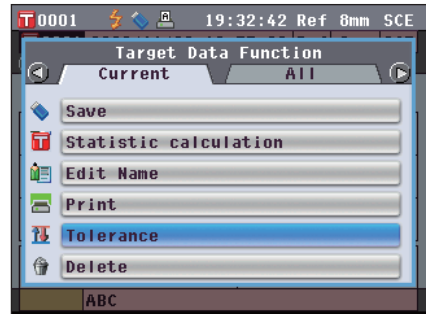

Delete

Delete the target color data.

[Notes] When the data is protected, you cannot select “Delete” on the **<Target Data Function>** screen.

[Procedure]

Start the procedure from the **<Target Data Function>** screen.

- Use the **◀** or **▶** button of the cross key to select the “Current” tab, use the **▲** or **▼** button to move the cursor to “Delete”, and then press the **[OK/Edit]** button. The **<Delete Target Data>** screen is displayed.
- Use the **◀** button of the cross key to move the cursor to “OK” and press the **[OK/Edit]** button. The data is deleted.
 - When the deletion is complete, the screen returns to the **<Target>** screen.
 - When you place the cursor on “Cancel” and press the **[OK/Edit]** button, the deletion is canceled and the screen returns to the **<Target Data Function>** screen.

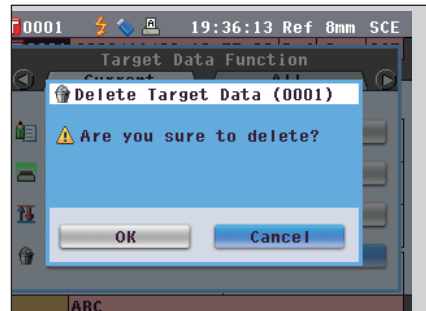

Target	
10°/D65	
L*	---
C*	---
h	---

Save to USB memory device

Save all target color data stored in the instrument to the USB memory device.

The USB memory device must be connected to the instrument before saving the data. For the connection of a USB memory device, refer to page 141 “Connecting a USB Memory”.

Memo A USB keyboard can also be used to input file names. For information on connecting a USB keyboard, refer to page 143 “Connecting a USB Keyboard”.

[Setting Procedure]

Start the procedure from the <Target Data Functions> screen.

1. Use the ◀ or ▶ button of the cross key to select the “All” tab, use the ▲ or ▼ button to move the cursor to “Save”, and then press the [OK/Edit] button.

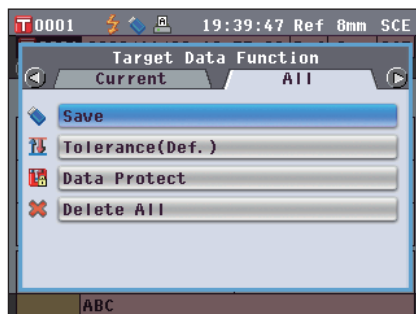

2. The <Target List> screen appears, with all targets initially selected (check marks shown in the box to the left of the target name).

- To deselect a target with a check mark, move the cursor to the target and then press the [OK/Edit] button.
- To deselect all targets shown on the screen, use the ▲ or ▼ button of the cross key to move the cursor to the “Page” button and then press the [OK/Edit] button. The check marks to the left of all targets shown will disappear.
- Use the ◀ or ▶ button of the cross key to move to other pages in instrument memory. Selected data will remain selected even if pages are changed.



3. When selection/deselection of targets has been completed, use the ▲ or ▼ button of the cross key to move the cursor to the “Save” button and then press the [OK/Edit] button.

The <Save Target Data> screen is displayed with a suggested file name shown.



4. To change the file name, use the ▲ or ▼ button of the cross key to move the cursor to “File Name” and then press the [OK/Edit] button.

The <Edit Name> screen is displayed.

Memo Connect a USB keyboard to input file names using the USB keyboard.



5. Use **←** and **→** or **↑** and **↓** buttons of the cross key to move the cursor around the characters and then press the **[OK/Edit]** button.
The selected character is displayed in the text box.



6. Repeat Step 5 until you enter necessary characters.
- You can use the **↑** or **↓** button of the cross key to move the blue box cursor on the text box. In this status, you can move the character position and modify the character by pressing the **←** or **→** button of the cross key.
 - To delete the character to the left of the cursor in the text box, press the **[CAL]** button.
 - Up to 20 characters can be used.



7. When you are finished entering characters, use **←** and **→** or **↑** and **↓** buttons of the cross key to move the cursor to “Save” and then press the **[OK/Edit]** button.
The setting is confirmed and the screen returns to the **<Save Target Data>** screen.

- Memo**
- If you press the **[Back]** button during the setting, “Do you want to save the changes?” is displayed. When you place the cursor on “OK” and press the **[OK/Edit]** button, the setting details are confirmed and the screen returns to the **<Save Target Data>** screen. When you place the cursor on “Cancel” and press the **[OK/Edit]** button, the setting details are not changed and the screen returns to the **<Save Target Data>** screen.
 - Disconnect any USB keyboards connected to the instrument.

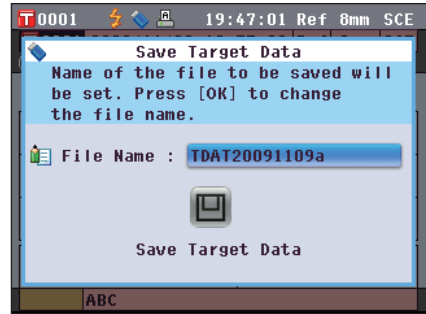

8. Connect the USB memory device. To accept the displayed file name, use the **↑** or **↓** button of the cross key to move the cursor to **Save Target Data** and then press the **[OK/Edit]** button.
- The **<Saving...>** screen is displayed.
 - When the saving is complete, the screen returns to the **<Target>** screen.

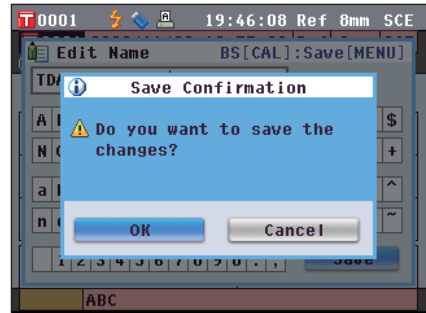

Target	
10°/D65	
L*	74.90
C*	40.62
h	71.80

Default Tolerance Setting

This instrument allows tolerance setting for individual target color data. Before setting such individual tolerance, the instrument is set with default tolerance. This section describes the procedure to set default tolerance.

- Memo**
- Before tolerance is specified for individual target colors, the instrument is set with default tolerance.
 - When you change default tolerance after tolerance has been set for individual target colors, the tolerance specified for these target colors will not be changed.
 - With the optional Color Management Software “SpectraMagic™ NX”, you can set or use the color difference tolerance easily.
 - The default tolerance setting items are the same as those of the color space or index currently selected for the display conditions.

[Setting Procedure]

Start the procedure from the <Target Data Function> screen.

1. Use the \leftarrow or \rightarrow button of the cross key to select the “All” tab, use the \uparrow or \downarrow button to move the cursor to “Tolerance (Def.)”, and then press the [OK/Edit] button.

The <Tolerance (Def.)> screen is displayed.



2. Use the \uparrow and \downarrow button of the cross key \leftarrow or \rightarrow to move the cursor to the desired item.



3. Press the [OK/Edit] button to change the details.
 - When the selected item is not currently checked, pressing the [OK/Edit] button causes the item to be checked, and you can change the setting value.
 - When the selected item is not currently checked, pressing the [OK/Edit] button makes the item be checked. Press the \leftarrow button of the cross key to move the blue box cursor to the setting value area. When you press the [OK/Edit] button, the cursor appears on the value. Press the \leftarrow or \rightarrow button of the cross key to change the value.

Memo You can move the cursor between the digits of the value by pressing the \leftarrow or \rightarrow button of the cross key.



Settings

○0.1 to 20.0

* Settings of x and y are 0.001 to 0.200.

- You need to press the [OK/Edit] button to confirm the change every time you change the setting of an item.

4. When you finish all settings, press the  button or [MENU] button of the cross key to move the cursor on “Save”, and then press the [OK/Edit] button. The setting is confirmed and the screen returns to the <Target Data Function> screen.

Memo If you press the [Back] button during the setting, the <Save Confirmation> screen is displayed. When you place the cursor on “OK” and press the [OK/Edit] button, the setting details are confirmed. When you place the cursor on “Cancel” and press the [OK/Edit] button, the setting details are not changed. After that, the screen returns to the <Target Data Function> screen.

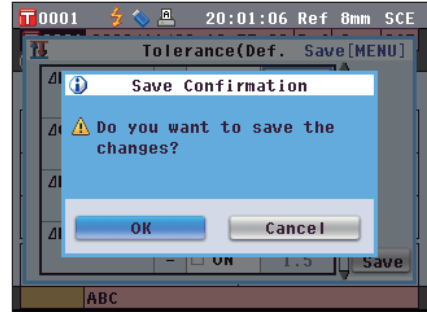
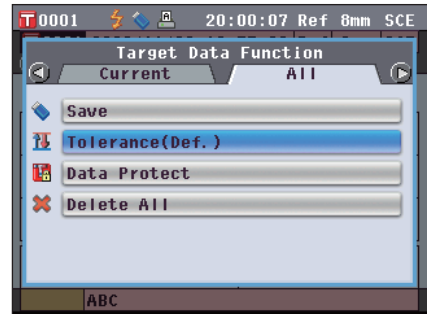

Data Protection

You can specify data protection so that the saved target color setting will not be deleted or changed by accident. When the data protection is set, you cannot select “Edit Name”, “Tolerance”, “Delete”, “Statistic calculation” and “Delete All” on the <Target Data Function> screen.

[Setting Procedure]

Start the procedure from the <Target Data Function> screen.

1. Use the ◀ or ▶ button of the cross key to select the “All” tab, use the ▲ or ▼ button to move the cursor to “Data Protect”, and then press the [OK/Edit] button. The <Data Protect> screen is displayed.

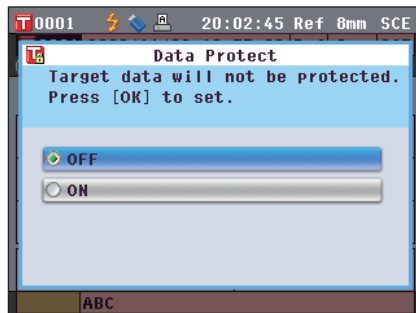

2. Use the ▲ or ▼ button of the cross key to move the cursor to the desired item.

Settings

- ON: Protect the data.
- OFF: Do not protect the data.

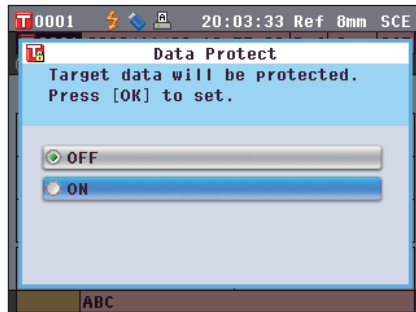

3. Press the [OK/Edit] button. The selection is confirmed and the screen returns to the <Target> screen.

Notes If you press the [Back] button without pressing the [OK/Edit] button, you return to the <Target Data Function> screen without changing the setting.

The screenshot shows the 'Target' screen. At the top, it displays 'T 0001', a battery icon, a signal icon, a printer icon, the time '20:04:27', and 'Ref 8mm SCE'. Below this, it shows 'T 0001 2009/11/09 18:57:28 Ref 8mm SCE' and 'Target'. There are navigation icons and a 'LIST' button. The main content is a table with the following data:

10°/D65	
L*	74.90
C*	40.62
h	71.80

At the bottom of the screen, the label 'ABC' is visible.

Delete All

Delete all the target color data which have been set.

Notes When the data is protected, you cannot select “Delete All” on the <Target Data Function> screen.

[Setting Procedure]

Start the procedure from the <Target Data Function> screen.

1. Use the ◀ or ▶ button of the cross key to select the “All” tab, use the ▲ or ▼ button to move the cursor to “Delete All”, and then press the [OK/Edit] button. The <Delete All Target> screen is displayed.

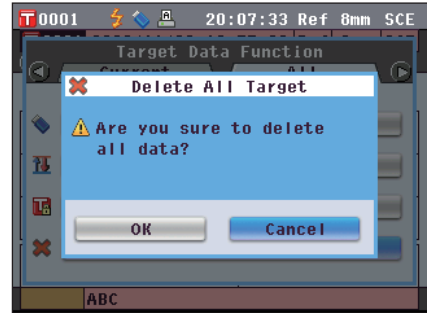

2. Use the ◀ button of the cross key to move the cursor to “OK” and press the [OK/Edit] button. The data is deleted.
 - When the all data is deleted, the screen returns to the <Target> screen.
 - When you place the cursor on “Cancel” and press the [OK/Edit] button, all data deletion is canceled and the screen returns to the <Target Data Function> screen.

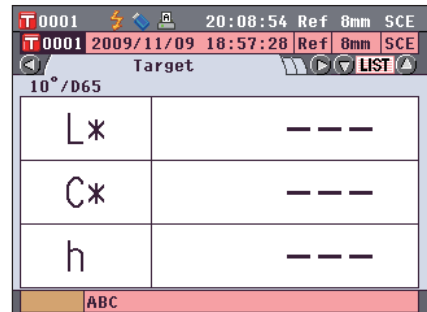





Other Settings



Setting Automatic White Calibration (100% Calibration) to ON/OFF

Set whether to perform white calibration (100% Calibration) automatically when the power switch of the instrument is set to ON.

[Setting Procedure]

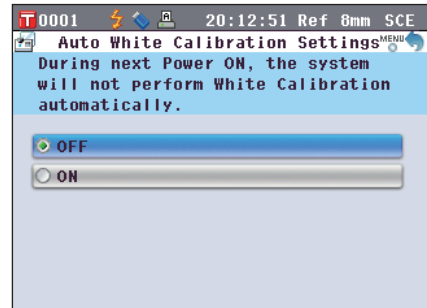
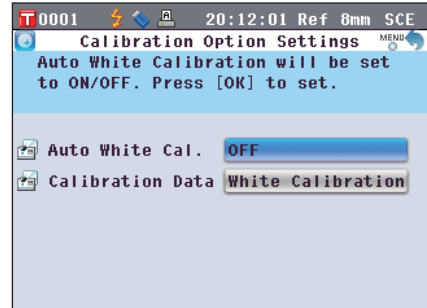
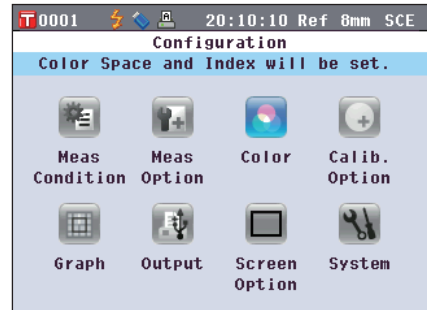
1. Press the [MENU] button.
The <Configuration> screen is displayed.
2. Use the  or  button of the cross key to move the cursor to “Calibration Options” and then press the [OK/Edit] button.
The <Calibration Option Settings> screen is displayed.
The <Calibration Option Settings> screen shows the current setting of each item.
3. Use the  or  button of the cross key to move the cursor to “Automatic White Cal.” and then press the [OK/Edit] button.
The <Auto White Calibration Settings> screen is displayed.



4. Use the  or  button of the cross key to move the cursor to the desired item.

Settings

- OFF : Disable automatic white calibration (100% Calibration) the next time the instrument is turned ON (the power switch is set to ON).
- ON : Enable automatic white calibration (100% Calibration) the next time the instrument is turned ON (the power switch is set to ON).

Memo When you set automatic white calibration to ON, white calibration (100% calibration) is automatically performed after the power switch of the instrument is set to ON before the <Welcome to Easy Setup Wizard!> screen appears. If you have disabled the display of the <Welcome to Easy Setup Wizard!> screen, the <Sample> screen is displayed immediately after the instrument is turned ON and white calibration (100% calibration) is performed. This allows you to start measurement quickly. This function is useful when you always perform measurement using the same condition settings.

For the procedure of disabling the display of the <Welcome to Easy Setup Wizard!> screen, refer to page 102.

5. Press the [OK/Edit] button.

The selection is confirmed and the screen returns to the <Calibration Option Setting> screen.

Notes If you press the [Back] button without pressing the [OK/Edit] button, you return to the <Calibration Option Settings> screen without changing the setting.

6. After you set the calibration options, press the [Back] button to return to the <Configuration> screen.

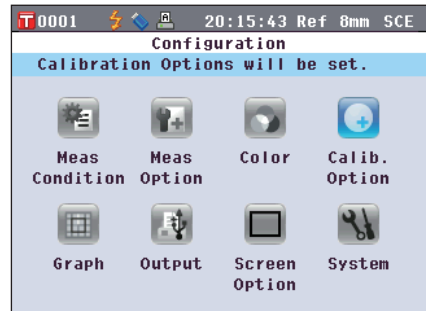
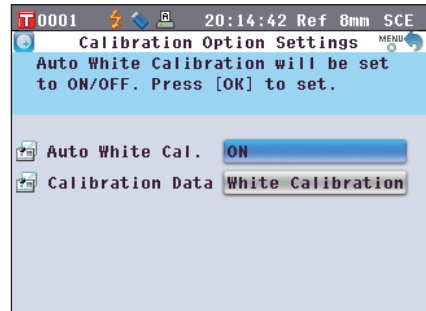
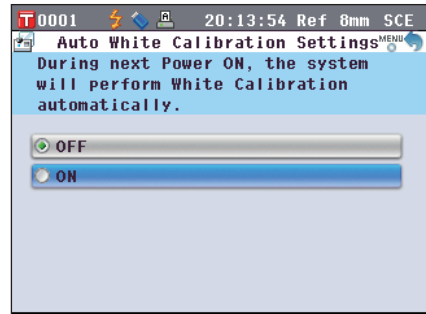

Setting the Measurement Result Display

To set details about the measurement result display, select “Graph” from the <Configuration> screen.

[Setting Procedure]

1. Press the [MENU] button.
The <Configuration> screen is displayed.
2. Use the ▲ or ▼ button of the cross key to move the cursor to “Graph” and then press the [OK/Edit] button.
The <Graph and Data Settings> screen is displayed.
3. After you set the graph display options, press the [Back] button to return to the <Graph and Data Settings> screen.

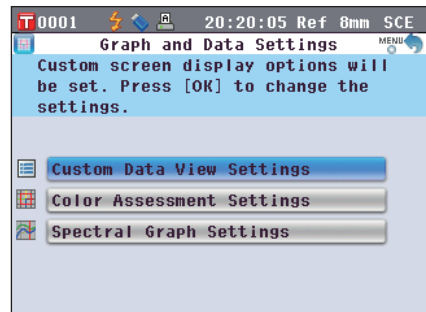
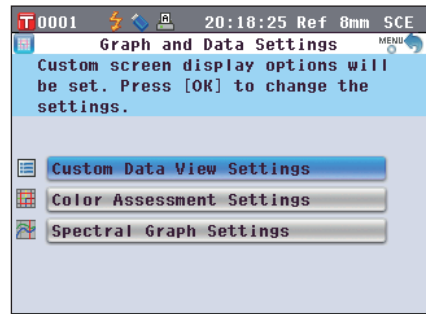
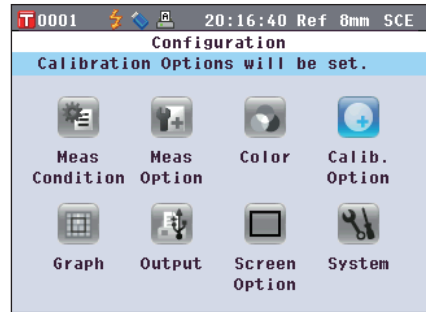



Setting the Custom Data Screen to ON/OFF

The measurement result display function allows you to switch between various screens including “Absolute” or “Difference”. You can add the “Custom Data” screen showing your desired items to these screens. This section describes the procedure to set whether to display this “Custom Data” screen.

Memo To set the items displayed on the “Custom” screen, you need to use the optional Color Management Software SpectraMagic™ NX. For details, refer to the instruction manual of SpectraMagic™ NX.

[Setting Procedure]

Start the procedure from the <Graph and Data Settings> screen.

1. Use the  or  button of the cross key to move the cursor to “Custom Data View Settings” and then press the [OK/Edit] button.

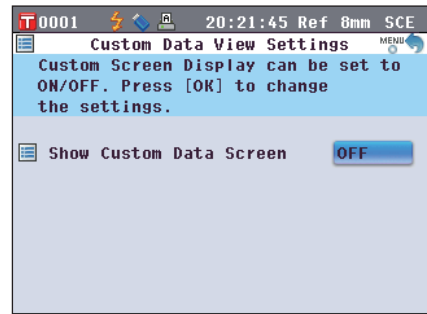

The <Custom Data View Settings> screen is displayed.

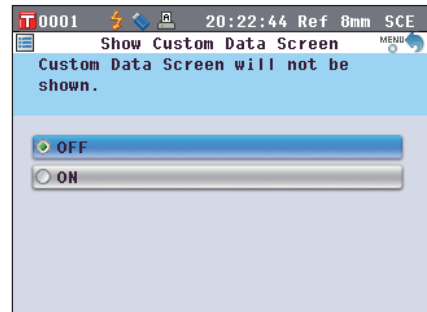

2. Press the [OK/Edit] button.

The <Show Custom Data Screen> screen is displayed.



3. Use the  or  button of the cross key to move the cursor to the desired item.

Settings

- OFF : The “Custom Data” screen is not displayed as the measurement result screen.
- ON : The “Custom Data” screen is displayed as one of the measurement result screens.

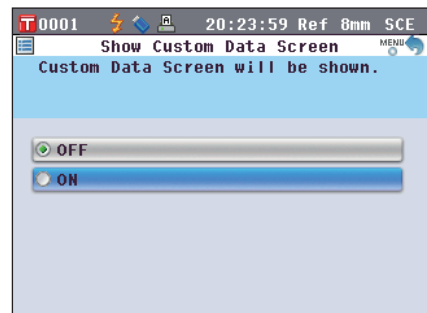

4. Press the [OK/Edit] button.

The selection is confirmed and the screen returns to the <Custom Data View Settings> screen.

Notes If you press the [Back] button without pressing the [OK/Edit] button, you return to the <Custom Data View Settings> screen without changing the setting.

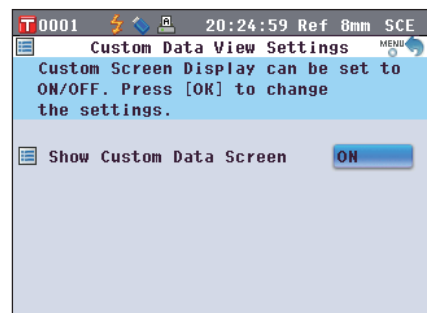

5. Press the [Back] button.

The screen returns to the <Graph and Data Settings> screen.

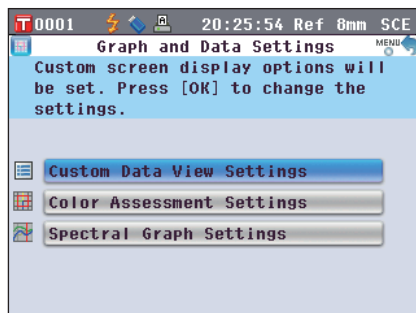

Setting the Assess. Graph Screen to ON/OFF

The measurement result display function allows you to switch between various screens including “Absolute” or “Difference”. You can add the “Assess. Graph” screen based on tone data to these screens. This section describes the procedure to set whether to display this “Assess. Graph” screen.

[Setting Procedure]

Start the procedure from the <Graph and Data Settings> screen.

1. Use the or button of the cross key to move the cursor to “Color Assessment Settings” and then press the [OK/Edit] button.

The <Color Assessment Settings> screen is displayed.

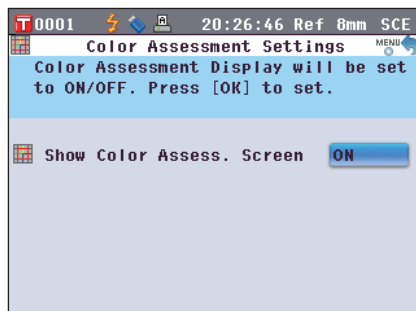

2. Press the [OK/Edit] button.

The <Show Color Assess.> screen is displayed.

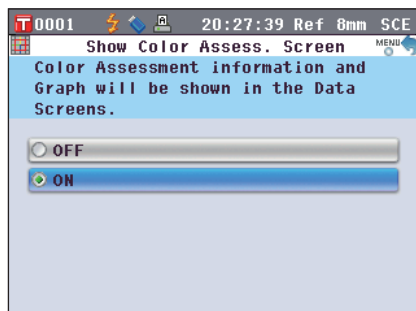

3. Use the or button of the cross key to move the cursor to the desired item.

Settings

- OFF : The <Assess. Graph> screen is not displayed as the measurement result screen.
- ON : The <Assess. Graph> screen is displayed as one of the measurement result screens.

[Memo] When the color assessment is set to ON, the <Assess. Graph> screen is displayed instead of the <Diff.Graph> screen. Moreover, color assessment is added to the <Difference> screen.

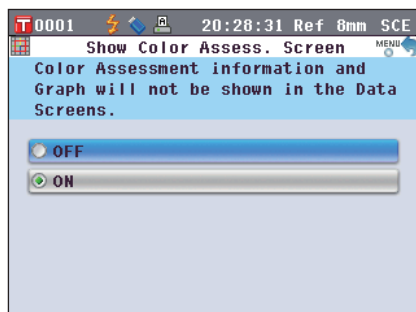

4. Press the [OK/Edit] button.

The selection is confirmed and the screen returns to the <Color Assessment Settings> screen.

Notes If you press the [Back] button without pressing the [OK/Edit] button, you return to the <Color Assessment Settings> screen without changing the setting.

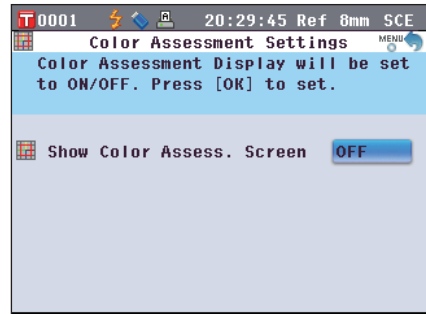

5. Press the [Back] button.

The screen returns to the <Graph and Data Settings> screen.

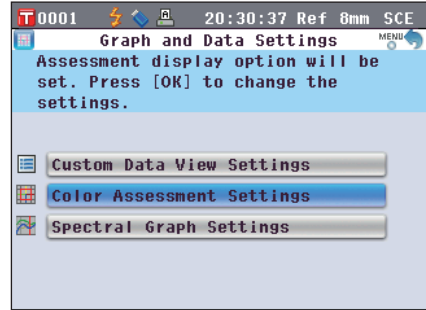

Setting the Spectral Graph Data Display

The measurement result display function allows you to switch between various screens including “Absolute” and “Difference”, and the “Spectral” screen which shows a spectral graph is one of them.

This section describes the procedure to set whether to show spectral data on this “Spectral” screen.

[Setting Procedure]

Start the procedure from the <Graph and Data Settings> screen.

1. Use the \blacktriangle or \blacktriangledown button of the cross key to move the cursor to “Spectral Graph Settings” and then press the [OK/Edit] button.

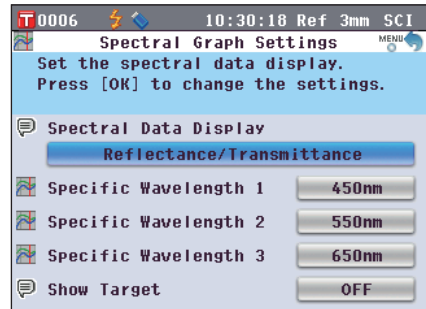

The <Spectral Graph Settings> screen is displayed.

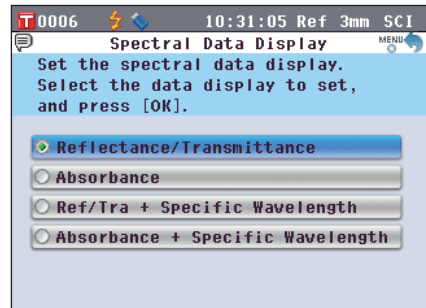

2. Use the \blacktriangle or \blacktriangledown button of the cross key to move the cursor to “Spectral Data Display” and then press the [OK/Edit] button.

The <Spectral Data Display> screen is displayed.



3. Use the  or  button of the cross key to move the cursor to the desired item.



Settings



- Reflectance/Transmittance: “Spectral” screen shows reflectance (or transmittance) graph without reflectance (or transmittance) data at selected wavelengths.
- Absorbance: “Spectral” screen shows absorbance graph without absorbance data at selected wavelengths.
- Refl/Tra + Specific Wavelength: “Spectral” screen shows reflectance (or transmittance) graph and reflectance (or transmittance) data at up to three selected wavelengths.
- Absorbance + Specific Wavelength: “Spectral” screen shows absorbance graph and absorbance data at up to three selected wavelengths.

4. Press the [OK/Edit] button.



The selection is confirmed and the screen returns to the <Spectral Graph Settings> screen.

Notes If you press the [Back] button without pressing the [OK/Edit] button, you return to the <Spectral Graph Settings> screen without changing the setting.

5. To change the wavelength of the spectral data to be displayed, use the  or  button of the cross key to move the cursor to “Specific Wavelength 1” and then press the [OK/Edit] button.

The cursor color turns to blue and  and  are displayed above and below the cursor.

6. Use the  or  button of the cross key to change the wavelength.

- The wavelength increases/decreases by 10 nm with each button press.
- Holding down the  or  button of the cross key increases/decreases the wavelengths by 10 nm continuously.

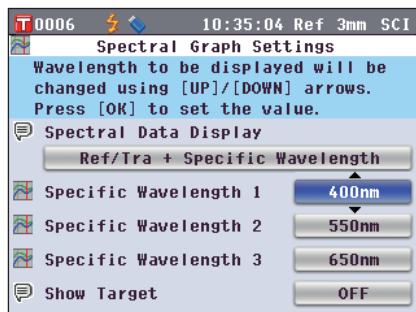
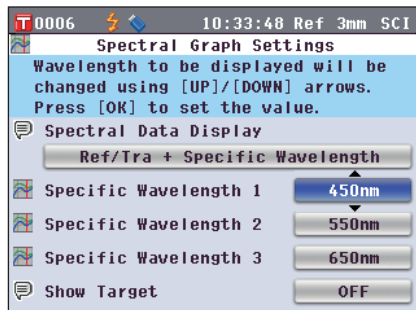
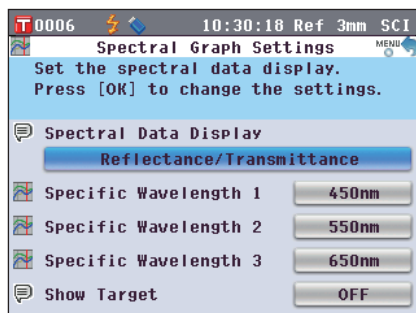
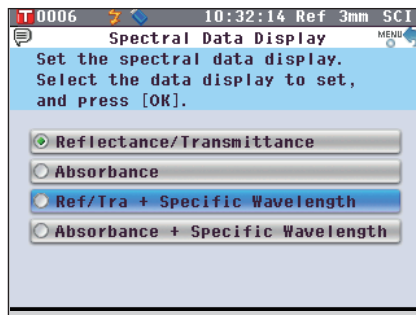

7. Press the [OK/Edit] button.

The selection is confirmed and the screen returns to the <Spectral Graph Settings> screen.

Notes If you press the [Back] button without pressing the [OK/Edit] button, you return to the <Spectral Graph Settings> screen without changing the setting.

8. Repeat Steps 5 to 7 for “Specific Wavelength 2” and “Specific Wavelength 3”.

9. To select whether or not the target data curve will be shown on the graph, use the ◀ or ▶ button of the cross key to move the cursor to “Show Target” and then press the [OK/Edit] button.

10. Use the ▲ or ▼ button of the cross key to move the cursor to the desired item.

Settings

Off : Target data curve is not shown on the spectral graph.

On : Target data curve is shown on the spectral graph.

11. When all of the necessary changes have been made, press the [Back] button.

The screen returns to the <Graph and Data Settings> screen.

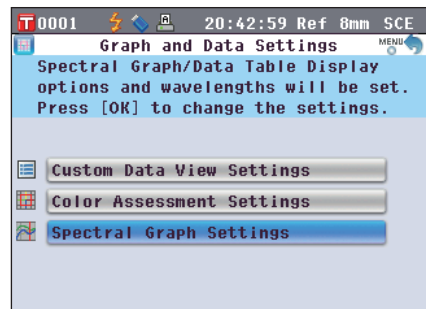
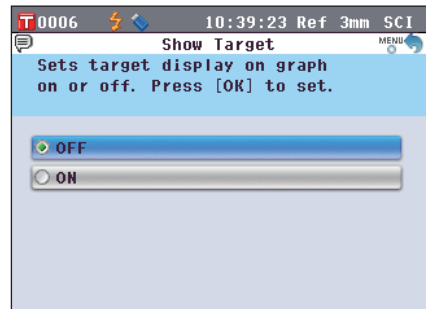
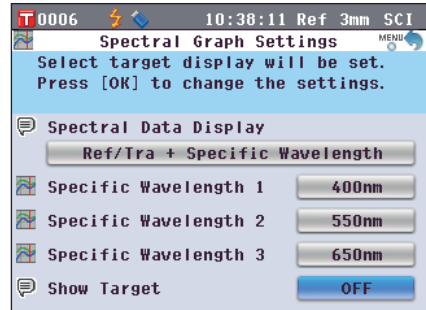
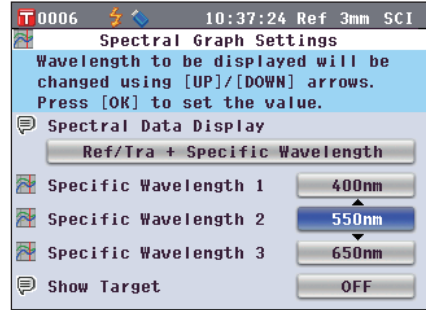
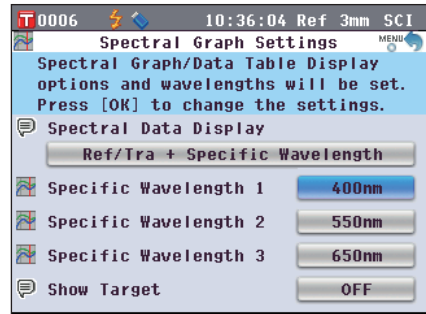

Setting the Screen Options

To set screen options, select “Screen Option” from the <Configuration> screen.

[Setting Procedure]

1. Press the [MENU] button.

The <Configuration> screen is displayed.

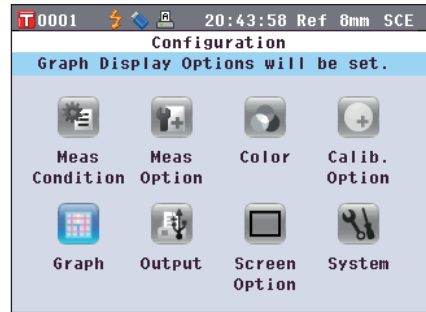

2. Use the ▲ or ▼ button of the cross key to move the cursor to “Screen Option” and then press the [OK/Edit] button.

The <Screen Option Settings> screen is displayed.

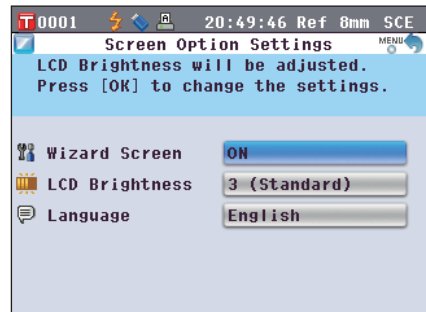

3. After you set the screen options, press the [Back] button to return to the <Configuration> screen.

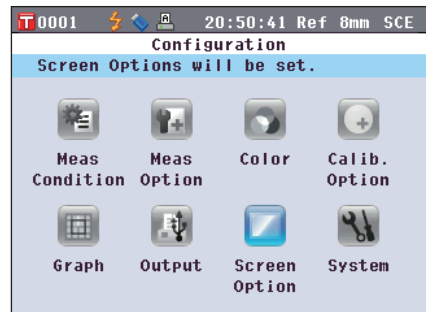



Setting the Quick Setting Wizard Display to ON/OFF



When the power switch of the instrument is set to ON, the <Welcome to Easy Setup Wizard!> screen is normally displayed and you can set the measurement conditions and calibrate the instrument step by step by following the instructions on the screen. This section describes the procedure to set whether to display this <Welcome to Easy Setup Wizard!> screen.

[Setting Procedure]

Start the procedure from the <Screen Option Settings> screen.

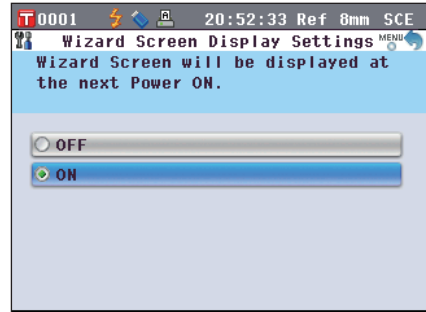
1. Use the  or  button of the cross key to move the cursor to “Wizard Screen” and then press the [OK/Edit] button.
The <Wizard Screen Display Settings> screen is displayed.



2. Use the  or  button of the cross key to move the cursor to the desired item.
Settings

- OFF : Do not display the <Welcome to Easy Setup Wizard!> screen the next time the instrument is turned ON (the power switch is set to ON).
- ON : Display the <Welcome to Easy Setup Wizard!> screen the next time the instrument is turned ON (the power switch is set to ON).

Memo When OFF is selected, the <Welcome to Easy Setup Wizard!> screen is not displayed after the power switch of the instrument is set to ON.

If you have set automatic white calibration to ON, white calibration (100% Calibration) is performed automatically after the instrument is turned ON, and then the <Sample> screen is displayed. This allows you to start measurement quickly. This function is useful when you always perform measurement using the same condition settings.

For the procedure to enable automatic white calibration, refer to page 93.

3. Press the [OK/Edit] button.

The selection is confirmed and the screen returns to the <Screen Option Settings> screen.

Notes If you press the [Back] button without pressing the [OK/Edit] button, you return to the <Screen Option Settings> screen without changing the setting.

Memo Whether to display the wizard can also be set by selecting or unselecting “Yes” for “Display Quick Setting Wizard every time.” on the <Welcome to Easy Setup Wizard!> screen.

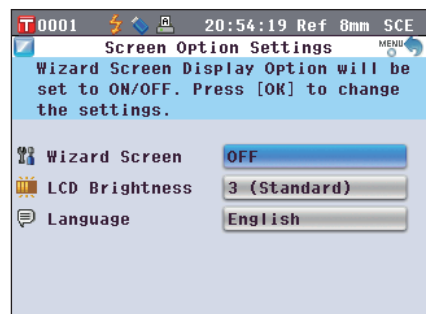
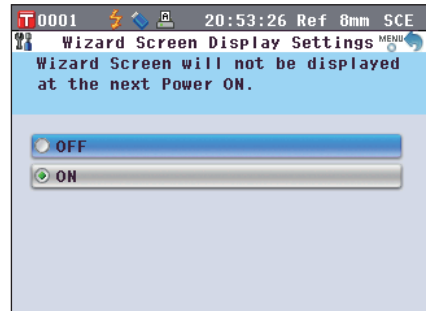



Setting the LCD Brightness

The brightness of the LCD can be set in five levels. Selecting a darker level is effective for power saving.

Memo The brightness level is factory-set to “3 (Standard)”.



[Setting Procedure]

Start the procedure from the <Screen Option Settings> screen.

1. Use the  or  button of the cross key to move the cursor to “LCD Brightness” and then press the [OK/Edit] button.

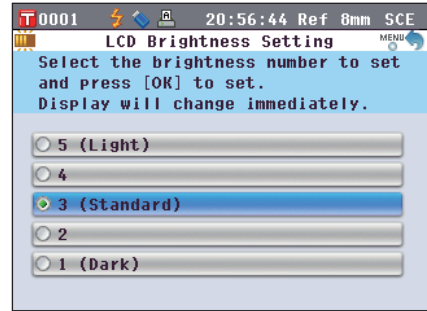
The <LCD Brightness Setting> screen is displayed.



2. Use the  or  button of the cross key to move the cursor to the desired item.

Settings

- 5 (Light)
- 4
- 3 (Standard)
- 2
- 1 (Dark)

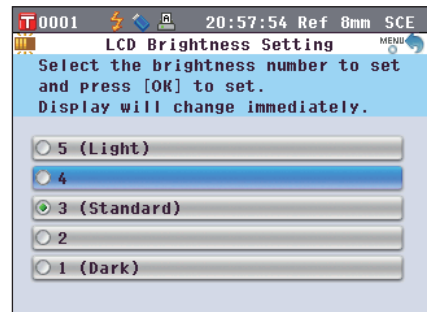

3. Press the [OK/Edit] button.

The selection is confirmed and the screen returns to the <Screen Option Settings> screen.

Notes If you press the [Back] button without pressing the [OK/Edit] button, you return to the <Screen Option Settings> screen without changing the setting.

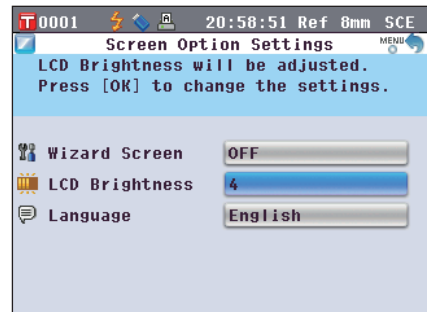

Setting the Display Language



The display language can be changed from the factory-set language. Available languages are: English, Japanese, German, French, Spanish, Italian, Chinese, and Portuguese.

Memo The language is factory-set to “English”.

Notes When the backup battery of the instrument has gone dead, the display language is reset to “English” regardless of the factory-set language.



[Setting Procedure]

Start the procedure from the <Screen Option Settings> screen.

1. Use the  or  button of the cross key to move the cursor to “Language” and then press the [OK/Edit] button.

The <Language> screen is displayed. The scroll bar at the right on the <Language> screen shows that there are additional language settings that cannot fit on the screen.



2. Use the  or  button of the cross key to move the cursor to the desired item.

Moving the cursor past the top or bottom of the list will show additional language settings that cannot fit on the screen.



3. Press the [OK/Edit] button.

The selection is confirmed and the screen returns to the <Screen Option Settings> screen.

Notes If you press the [Back] button without pressing the [OK/Edit] button, you return to the <Screen Option Settings> screen without changing the setting.

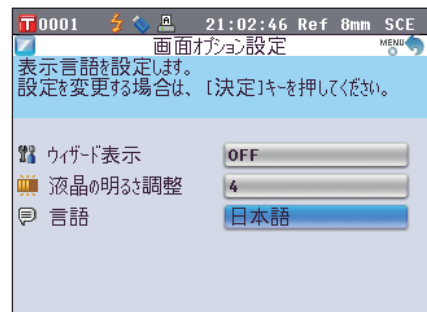

Setting the Date and Time

To set date and time, select “System” from the <Configuration> screen.

[Setting Procedure]

1. Press the [MENU] button.

The <Configuration> screen is displayed.

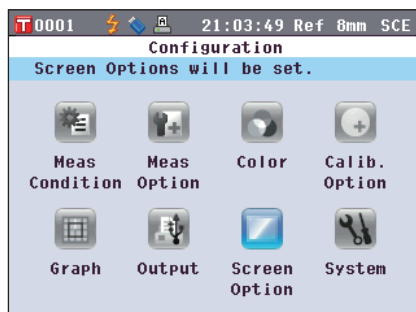

2. Use the or button of the cross key to move the cursor to “System” and then press the [OK/Edit] button.

The <System Settings> screen is displayed.

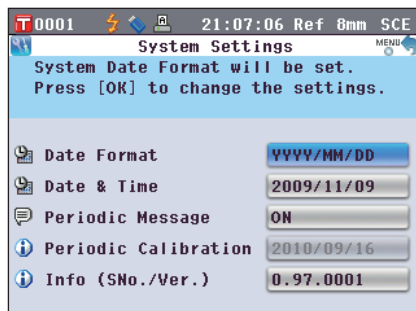

3. After you set the screen options, press the [Back] button to return to the <Configuration> screen.

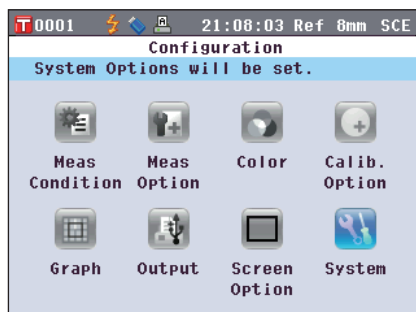

Setting the Clock

This instrument has a built-in clock to record the date and time of measurement. Since the date and time have been set at the factory, you do not need to change them under normal conditions. If necessary, you can change the date and time settings.



[Setting Procedure]



Start the procedure from the <System Settings> screen.

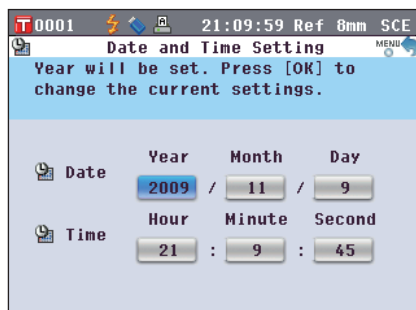

1. Use the or button of the cross key to move the cursor to “Date & Time” and then press the [OK/Edit] button.

The <Data and Time Setting> screen is displayed.





- Use the  or  button of the cross key to move the cursor to a desired item and then press the [OK/Edit] button.

The cursor color turns to blue and  and  are displayed above and below the cursor.

- Use the  or  button of the cross key to change the value.

Settings

- Year : 2009 to 2050
- Month : 1 to 12
- Day : 1 to 28, 29, 30 and 31 (varies with the selected month/year)
- Hour : 0 to 23
- Minute : 0 to 59
- Second : 0 to 59

- The value increases/decreases by one with each button press.
- Holding down the  or  button of the cross key increases/decreases the value by one continuously.

- Press the [OK/Edit] button.

The setting is confirmed.

Notes If you press the [Back] button without pressing the [OK/Edit] button, the setting is not changed.

- Repeat Steps 2 to 5 for each of the date (Year/Month/Day) and time (Hour:Minute:Second) parameters.

- When all of the necessary changes have been made, press the [Back] button.

The screen returns to the <System Settings> screen.

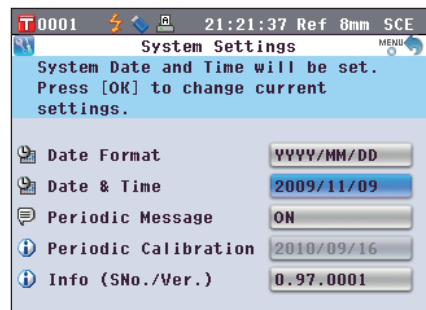
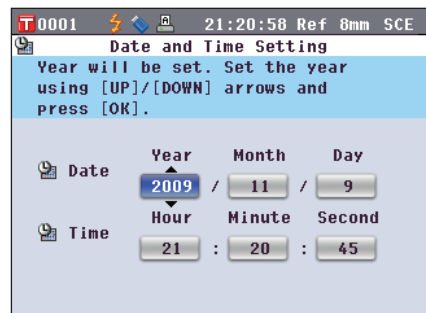
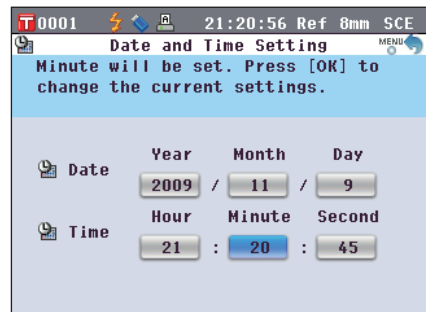
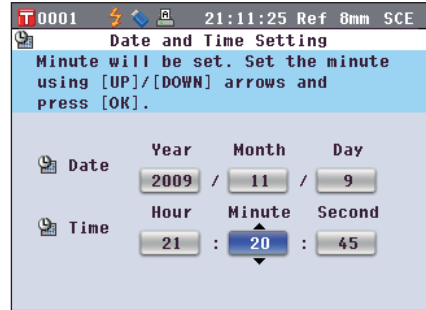
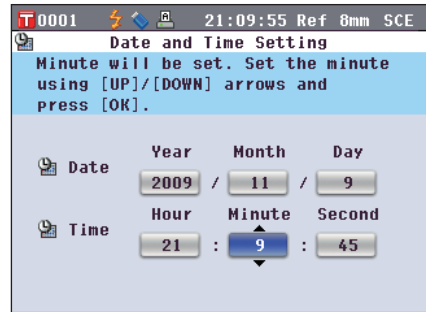

Setting the Date Format

You can change the format of the date displayed on the screen.

[Setting Procedure]

Start the procedure from the <System Settings> screen.

1. Use the **▲** or **▼** button of the cross key to move the cursor to “Date Format” and then press the [OK/Edit] button.

The <Date Format> screen is displayed.

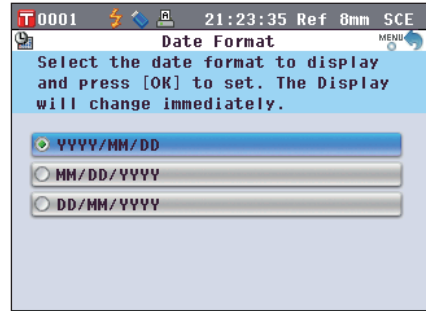

2. Use the **▲** or **▼** button of the cross key to move the cursor to the desired item.

Settings

- YYYY/MM/DD : Display the date in the format of year/month/day.
- MM/DD/YYYY : Display the date in the format of month/day/year.
- DD/MM/YYYY : Display the date in the format of day/month/year.

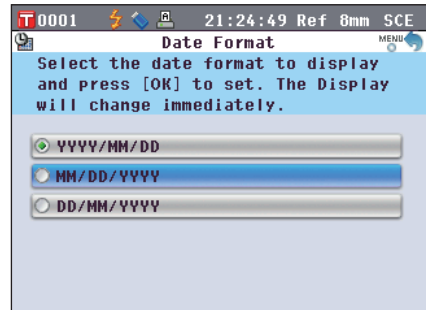

3. Press the [OK/Edit] button.

The selection is confirmed and the screen returns to the <System Settings> screen.

Notes If you press the [Back] button without pressing the [OK/Edit] button, you return to the <System Settings> screen without changing the setting.

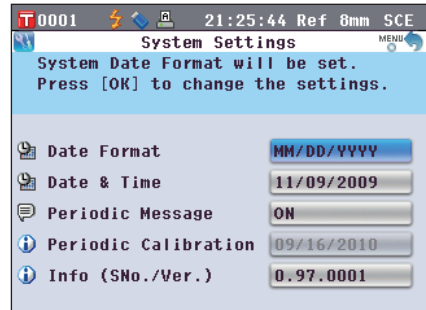

Batch Setting of Conditions

You can save various conditions (display conditions, measurement conditions, etc.) as a file in advance and set the conditions of the instrument all at once by loading the file.

[Preparation]

1. Press the [MENU] button.

The <Configuration> screen is displayed.

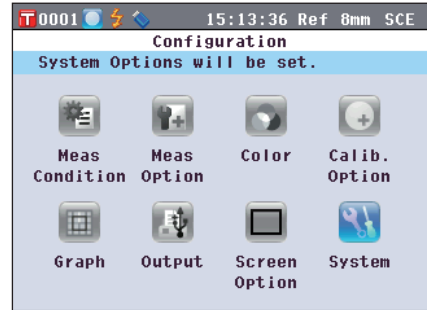

2. Use the ◀ or ▶ and ▲ or ▼ button of the cross key to move the cursor to “Output” and then press the [OK/ Edit] button.

The <Output Settings> screen is displayed.

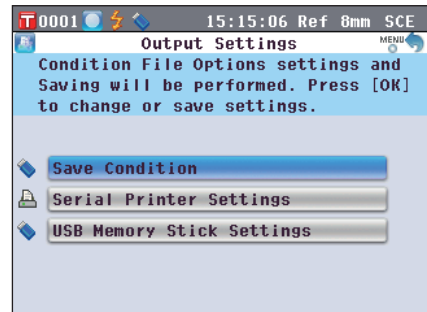

3. Connect a USB memory device to the USB connection terminal, use the ▲ or ▼ button of the cross key to move the cursor to “Save Condition” and then press the [OK/Edit] button.

The <Save Condition File> screen is displayed with a suggested file name being entered.

Notes The “Save Condition” option can be selected only when a USB memory device has been connected.

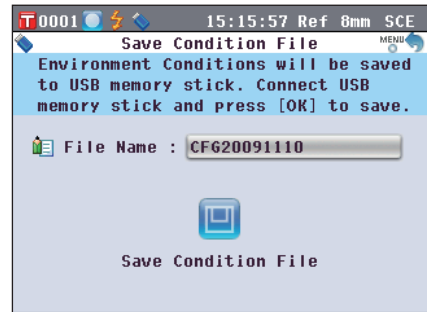



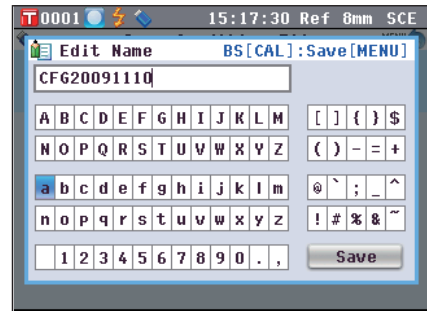

4. To change the file name, use the ▲ or ▼ button of the cross key to move the cursor to “File Name” and then press the [OK/Edit] button.

The <Edit Name> screen is displayed.





Memo A USB keyboard can also be used to input file names. For information on connecting a USB keyboard, refer to page 143 “Connecting a USB Keyboard”.







5. Use the  or  and  or  buttons of the cross key to move the cursor around the characters and then press the [OK/Edit] button.



The selected character is displayed in the text box.

6. Repeat Step 5 until you have entered the necessary characters.

- You can use the  or  button of the cross key to move the blue box cursor on the text box. In this status, you can move the character position and modify the character by pressing the  or  button of the cross key.
- To delete the character to the left of the cursor in the text box, press the [CAL] button.
- Up to 20 characters can be used.

7. When you are finished entering characters, use the  or  and  or  buttons of the cross key to move the cursor to “Save” and then press the [OK/Edit] button. The settings are confirmed and the screen returns to the <Save Condition File> screen.

Memo If you press the [Back] button during the setting, “Do you want to save the changes?” is displayed. When you place the cursor on “OK” and press the [OK/Edit] button, the setting details are confirmed and the screen returns to the <Save Condition File> screen. When you place the cursor on “Cancel” and press the [OK/Edit] button, the settings are not changed and the screen returns to the <Save Condition File> screen.

8. To accept the displayed file name, use the  or  button of the cross key to move the cursor to  “Save Condition” and then press the [OK/Edit] button.

- The <Saving...> screen is displayed.
- When the saving is complete, the screen returns to the <Output Settings> screen.

Memo A condition setting file stores the parameters of the following screens currently set in the instrument.

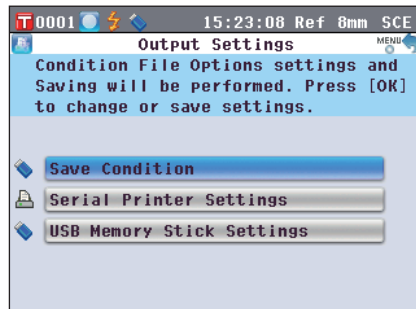
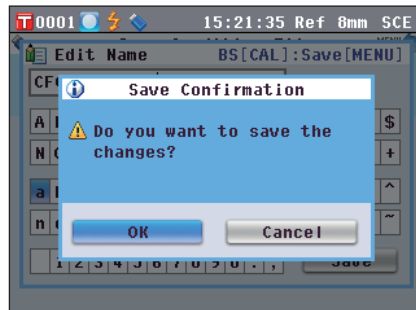
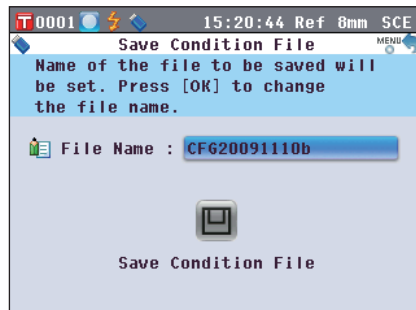
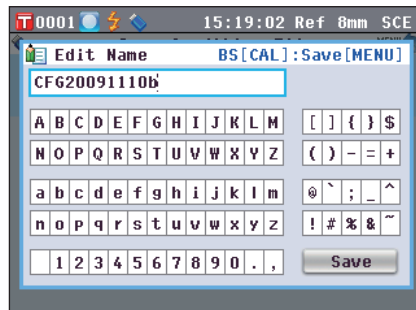
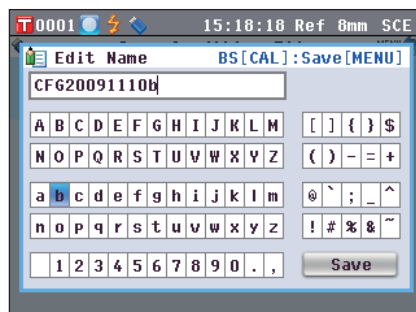

- <Measurement Condition Settings> screen “Meas. Type”, “Meas. Area”, “SCI/SCE”
- <Measurement Options> screen “Auto Measurement (1-10)”, “Manual Measurement (1-30)”
- <Color Settings> screen “Color Space”, “Color Index”, “Observer”, “Illuminant 1”, “Illuminant 2”
- <Calibration Option Settings> screen “Calibration Data”
- <Graph and Data Settings> screen “Custom Data View Settings”, “Color Assessment Settings”
- <Output Settings> screen “Serial Printer Settings”, “USB Memory Stick Settings”
- <Screen Option Settings> screen “LCD Brightness”
- <Target Data Function> screen “Data Protect”
- The extension of the condition setting file is “.cnd”.
- The condition setting file can also be created by using the optional Color Data Software SpectraMagic™ NX. When you create the condition setting file with SpectraMagic™ NX, you can set “User Index” as well as the items above. For details, refer to the instruction manual of SpectraMagic™ NX.

[Setting Procedure]

1. Turn the instrument ON.

The <Welcome to Easy Setup Wizard!> screen appears after the initial screen.

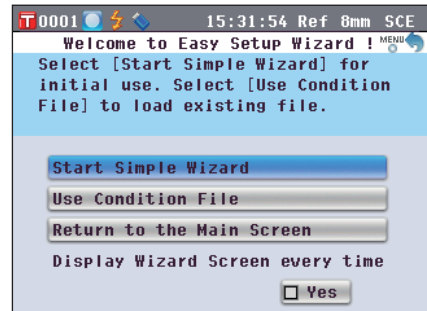

- ### 2. Connect the USB memory device containing the condition setting file (.cnd) to the USB connection terminal, use the ▲ or ▼ button of the cross key to move the cursor to “Use Condition File” and then press the [OK/Edit] button.

The <Select the Condition File> screen appears.

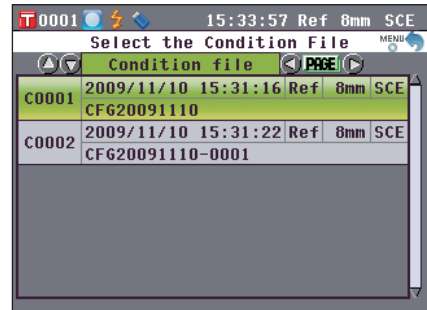

- ### 3. Use the ▲ or ▼ button of the cross key to move the cursor to the desired condition setting file and then press the [OK/Edit] button.

Memo When there are six or more files, you can switch the page by using the ◀ or ▶ button of the cross key.

- The <Loading...> screen is displayed.
- When the condition setting file has been loaded, the <Measurement Condition Settings> screen is displayed.

- Notes**
- After setting the conditions, you need to perform zero calibration (0% Calibration) and white calibration (100% Calibration). Go to page 52 “Calibration”.
 - If you change the conditions after the instrument is turned on, you need to perform zero calibration (0% Calibration) and white calibration (100% Calibration) again.

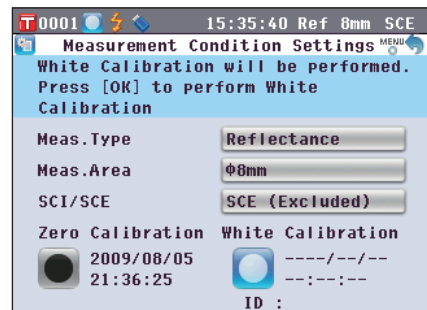
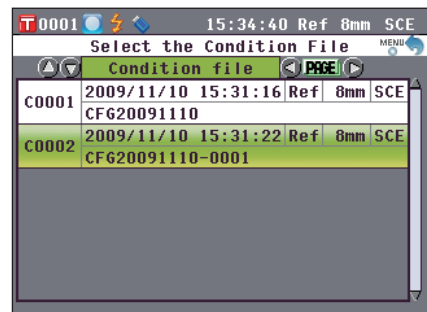

Chapter 3

Measurement

Measurement

Notes

- Prior to the start of measurement, be sure to perform white calibration (100% calibration). For details, refer to page 55 “White Calibration (100% Calibration)”.
- To display the color difference, it is necessary to set target colors before measurement.
- For accurate measurement, make sure to keep measurement conditions (ambient temperature, etc.) constant.

[Operating Procedure]

1. When a screen other than the <Sample> screen is displayed, press the [TARGET/SAMPLE] button.

The <Sample> screen is displayed.

- Every time the [Detail/List] button is pressed, the screen is switched between the <Sample> detail screen and <Sample> list screen.

Memo Measurement can be performed on either the <Sample> detail screen or <Sample> list screen.

2. Set the specimen on the Target Mask or Transmittance Specimen Chamber according to the measurement type.

T 0001		09:26:44	Ref 8mm SCE
S 0072		2009/11/08 07:12:22	Ref 8mm SCI
Sample			
10°/D65			
L*	68.03		
C*	56.73		
h	110.72		
			T0004

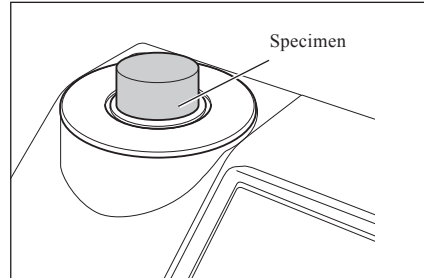

3. Make sure that (Measurement possible) is displayed and then press the [MEAS] button.

The specimen is measured and the result is displayed on the screen.

- The sample data No. is automatically assigned sequentially in the order of measurements.

Memo When the number of sample data sets stored in the memory reaches 4000, the number assigned to the subsequent sample data will always be No. 4000, and the oldest data will be deleted one at a time.

T 0001		09:27:50	Ref 8mm SCE
S 0073		2009/11/10 09:27:32	Ref 8mm SCE
Sample			
10°/D65			
L*	74.96		
a*	41.19		
b*	71.53		
			T0001

Displaying the Measurement Results

At the end of measurement, the measurement results will be displayed on the LCD according to the specified conditions. Typical measurement result screens are shown below.

Notes Measurement results cannot be switched when “Communicating” is displayed while the instrument is connected to a PC.

Memo You can switch the tab of the measurement screen with the **◀** or **▶** button of the cross key. For details of the screen switching, refer to page 120 “Switching the Display Contents of the Measurement Results”.
You can switch the sample data No. with the **▲** or **▼** button of the cross key.

<Sample> Detail Screen: Absolute

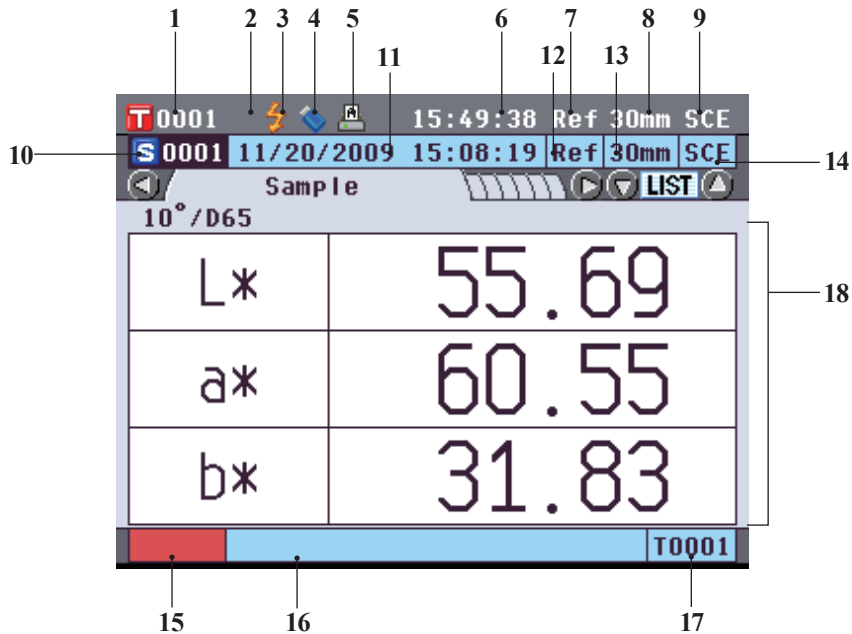

- 1 Data No. of the currently selected target color data
- 2 White calibration completed
- 3 Measurement possible
- 4 USB memory device connection (No connection when the icon is not displayed)
- 5 Automatic printing from serial printer set to ON (OFF when the icon is not displayed)
- 6 Current time
- 7 Current measurement type (Ref: Reflectance measurement, Tra: Transmittance measurement, Pet: Petri Dish measurement, Liq: Liquid measurement)
- 8 Current measurement area
- 9 Current specular component mode
For details of the status bar items 1 to 9, refer to page 22.
- 10 Sample data No.
- 11 Date and time of the measurement
- 12 Measurement type used for the measurement (Ref: Reflectance measurement, Tra: Transmittance measurement, Pet: Petri Dish measurement, Liq: Liquid measurement)
- 13 Measurement area used for the measurement
- 14 Specular component mode used for the measurement
- 15 Pseudocolor expressing the sample data
- 16 Name of the sample data
- 17 Data No. of the target color data used for the measurement
- 18 Sample data (The tab can be switched with the **◀** or **▶** button of the cross key.)

<Sample> Detail Screen: “Difference” Tab

T 0001 15:50:41 Ref 30mm SCE		
S 0001 11/20/2009 15:08:19 Ref 30mm SCE		
Difference		
ΔL^*	0.10	Lighter
Δa^*	0.04	+Red
Δb^*	0.00	
ΔE^*_{ab}	0.11	10°/D65
		Pass
T0001		

18 Sample data (The tab can be switched with the **◀** or **▶** button of the cross key.)

- ① Any color difference value which failed the pass/fail judgment based on the color difference tolerance will be highlighted in red.
- ② Pass/fail judgment: When the result was “Pass”, the background is shown in green. When the result was “Fail”, the background is shown in yellow.
- ③ When the color assessment settings is set to ON, the tones are displayed. For the procedure of setting the color assessment settings to ON/OFF, refer to page 97.

<Sample> Detail Screen: “Abs. & Diff.” Tab

T 0001 15:51:40 Ref 30mm SCE				
S 0001 11/20/2009 15:08:19 Ref 30mm SCE				
Abs. & Diff.				
10°/D65	L*	a*	b*	
Target	55.59	60.51	31.82	
Sample	55.69	60.55	31.83	
Diff.	0.10	0.04	0.00	
	ΔE^*_{ab}	0.11		
10°/C	L*	a*	b*	MI
Target	55.82	58.52	32.09	0.00
Sample	55.92	58.56	32.09	
Diff.	0.11	0.04	0.00	
	ΔE^*_{ab}	0.11		
				Pass
T0001				

18 Sample data (The tab can be switched with the **◀** or **▶** button of the cross key.)

- The upper section shows the sample data measured with illuminant 1, and the lower section shows the sample data measured with illuminant 2. If illuminant 2 has not been set, “---” will be displayed.
- ① Any color difference value which failed the pass/fail judgment based on the color difference tolerance will be highlighted in red.
- ② Pass/fail judgment: When the result was “Pass”, the background is shown in green. When the result was “Fail”, the background is shown in yellow.

<Sample> Detail Screen: “Custom” Tab

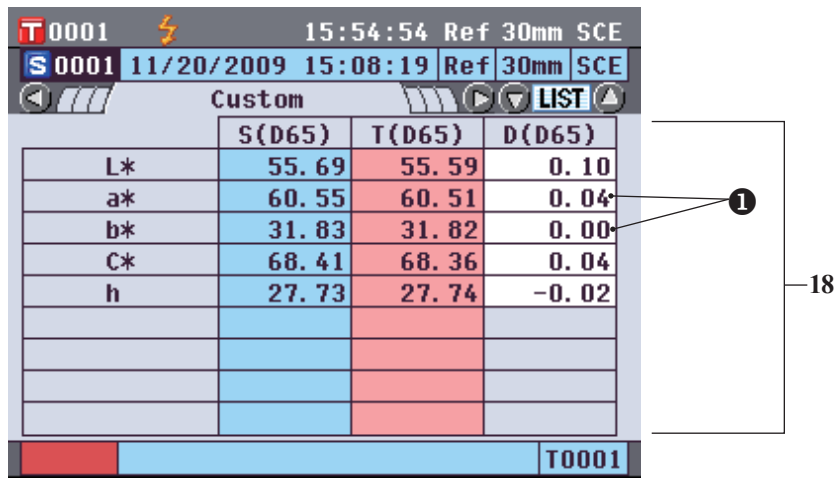

- 18 Sample data (The tab can be switched with the ◀ or ▶ button of the cross key.)
- This tab is displayed when the “Show Custom Data Screen” is set to ON. For the procedure of the “Show Custom Data Screen” to ON/OFF, refer to page 96.
 - Any color difference value which failed the pass/fail judgment based on the color difference tolerance will be highlighted in red.

Memo The items shown on the custom data screen should be set by using the optional Color Management Software SpectraMagic™ NX. For details, refer to the instruction manual of SpectraMagic™ NX.

<Sample> Detail Screen: “Abs.Graph” Tab

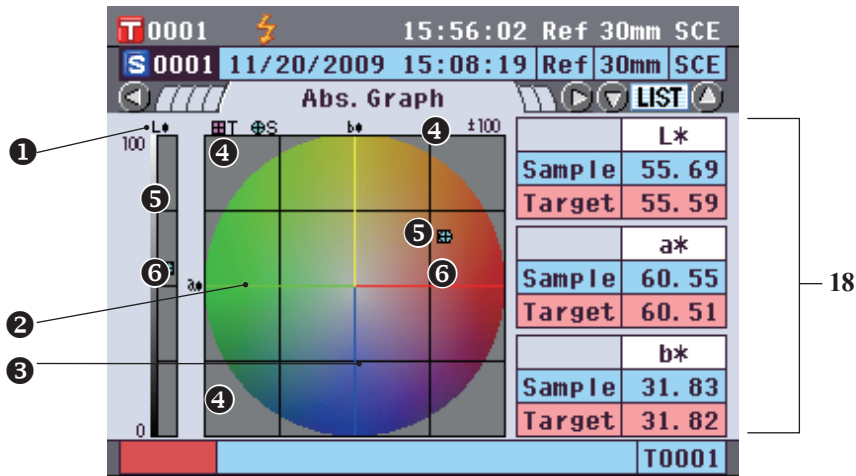

- 18 Sample data (The tab can be switched with the ◀ or ▶ button of the cross key.)
- L* axis (colorimetric graph)
 - a* axis (colorimetric graph)
 - b* axis (colorimetric graph)
 - Scales for the axes
 - Measuring point: Plotted with a light-blue circle (○).
 - Position of target color: Plotted with a pink square (□).

<Sample> Detail Screen: “Diff.Graph” Tab

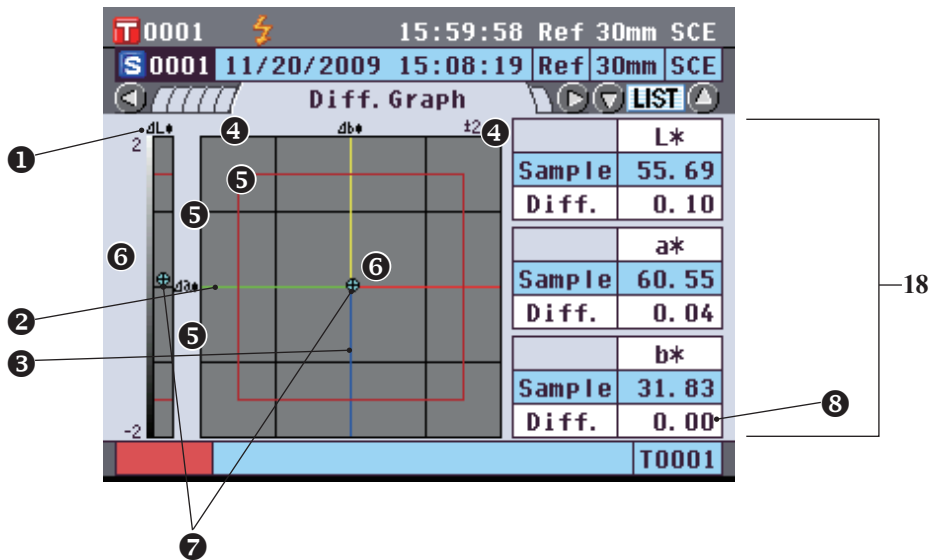

18 Sample data (The tab can be switched with the ◀ or ▶ button of the cross key.)

- ① ΔL^* axis (color difference graph)
- ② Δa^* axis (color difference graph)
- ③ Δb^* axis (color difference graph)
- ④ Scales for the axes
- ⑤ Color difference tolerance
- ⑥ Measuring point: Plotted with a light-blue circle (○).
- ⑦ Position of target color: This is the origin point of the graph.
- ⑧ The color difference value which failed the pass/fail judgment based on the color difference tolerance will be highlighted in red.

Notes The measuring point will not be shown on the graph when no target color is set for the sample data.

<Sample> Detail Screen: “Assess.Graph” Tab

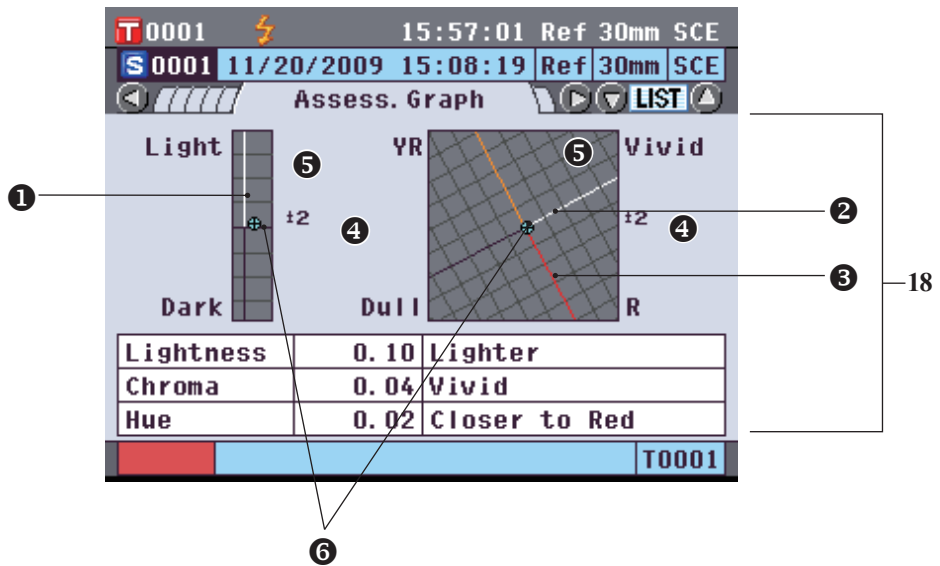

18 Sample data (The tab can be switched with the ◀ or ▶ button of the cross key.)

- ① Lightness axis
- ② Chroma axis
- ③ Hue axis
- ④ Scales for the axes
- ⑤ Measuring point: Plotted with a light-blue circle (○).
- ⑥ Position of target color: This is the origin point of the graph.

- Notes**
- The measuring point will not be shown on the graph when no target color is set for the sample data.
 - When color difference target is $ab = 0.0$ or $b^* = 0.00$, no graph is displayed.

<Sample> Detail Screen: “Spectral” Tab

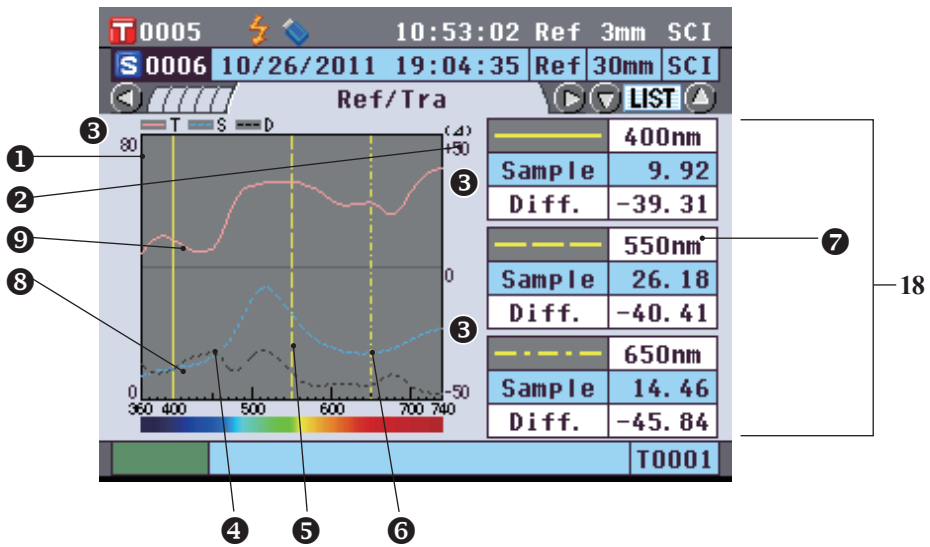

18 Sample data (The tab can be switched with the ◀ or ▶ button of the cross key.)

- ① Axis of spectral reflectance
- ② Axis of spectral reflectance difference
- ③ Scales of the axes
- ④ Position of the wavelength specified for “Spectral Wavelength 1” in the spectral graph setting:
Shown with a solid yellow line.
- ⑤ Position of the wavelength specified for “Spectral Wavelength 2” in the spectral graph setting:
Shown with a dashed yellow line.
- ⑥ Position of the wavelength specified for “Spectral Wavelength 3” in the spectral graph setting:
Shown with a dashed-dotted yellow line.
- ⑦ When “Spectral Data Display” is set to ON in the spectral graph setting, the spectral data for each selected wavelength is displayed. When “Spectral Data Display” is set to OFF, the spectral data is not displayed and the spectral graph is displayed on the full screen. For details of the spectral graph setting, refer to page 98.
- ⑧ Spectral graph of sample data: Shown with a solid light-blue line.
- ⑨ Spectral difference graph: Shown with a dashed black line.

<Sample> List Screen

Every time the [Detail/List] button is pressed, the screen is switched between the <Sample> detail screen and <Sample> list screen.

Memo Measurement can be performed on either the <Sample> detail screen or <Sample> list screen.

T 0005				10:59:32 Ref 3mm SCI	
Sample List				PAGE	
10	S 0001	10/26/2011 18:54:37	Ref	30mm	SCI
15	Test Sample #01			T0001	14
16	S 0002	10/26/2011 18:54:49	Ref	30mm	SCI
	Trial #2			T0001	17
	S 0003	10/26/2011 19:02:34	Ref	30mm	SCI
	Machine 5			T0001	
	S 0004	10/26/2011 19:02:38	Ref	30mm	SCI
	Line 1 12-10 AM			T0001	
	S 0005	10/26/2011 19:04:22	Ref	30mm	SCI
	New Color 3			T0001	
	S 0006	10/26/2011 19:04:35	Ref	30mm	SCI
	Forest Green			T0001	

- 10 Sample data No.
- 11 Date and time of the measurement
- 12 Measurement type used for the measurement (Ref: Reflectance measurement, Tra: Transmittance measurement, Pet: Petri Dish measurement, Liq: Liquid measurement)
- 13 Measurement area used for the measurement
- 14 Specular component mode used for the measurement
- 15 Pseudocolor expressing the sample data
- 16 Name of the sample data
- 17 Data No. of the target color data used for the measurement

Switching the Display Contents of the Measurement Results

The contents of the measurement result display can be changed by pressing the **⬅** or **➡** button of the cross key on the <Sample> detail screen. The contents to be displayed will vary depending on the setting.

Notes Measurement results cannot be switched when “Communicating” is displayed while the instrument is connected to a PC.

Memo When the number of sample data sets stored in the memory reaches 4000, the number assigned to the subsequent sample data will always be No. 4000, and the oldest data will be deleted one at a time.

Setting					1 Absolute		
Color Space	Illuminant 2	Custom Data View Settings	Color Assessment	Spectral Data Display			
L*a*b*, L*C*h	None (Initial setting)	OFF (Initial setting)	OFF (Initial setting)	ON (Initial setting)	<input type="radio"/>		
			ON	ON (Initial setting)	<input type="radio"/>		
		ON	OFF (Initial setting)	OFF	ON (Initial setting)	<input type="radio"/>	
			ON	ON (Initial setting)	OFF	<input type="radio"/>	
			ON	OFF	ON (Initial setting)	<input type="radio"/>	
			ON	ON (Initial setting)	OFF	<input type="radio"/>	
	Other than None	OFF (Initial setting)	OFF (Initial setting)	ON (Initial setting)	<input type="radio"/>		
			ON	ON (Initial setting)	<input type="radio"/>		
		ON	OFF (Initial setting)	OFF	ON (Initial setting)	<input type="radio"/>	
			ON	ON (Initial setting)	OFF	<input type="radio"/>	
			ON	OFF	ON (Initial setting)	<input type="radio"/>	
			ON	ON (Initial setting)	OFF	<input type="radio"/>	
Hunter Lab	None (Initial setting)	OFF (Initial setting)	OFF (Initial setting)	ON (Initial setting)	<input type="radio"/>		
			ON	ON (Initial setting)	<input type="radio"/>		
		ON	OFF (Initial setting)	OFF	ON (Initial setting)	<input type="radio"/>	
			ON	ON (Initial setting)	OFF	<input type="radio"/>	
			ON	OFF	ON (Initial setting)	<input type="radio"/>	
			ON	ON (Initial setting)	OFF	<input type="radio"/>	
	Other than None	OFF (Initial setting)	OFF (Initial setting)	ON (Initial setting)	<input type="radio"/>		
			ON	ON (Initial setting)	<input type="radio"/>		
		ON	OFF (Initial setting)	OFF	ON (Initial setting)	<input type="radio"/>	
			ON	ON (Initial setting)	OFF	<input type="radio"/>	
			ON	OFF	ON (Initial setting)	<input type="radio"/>	
			ON	ON (Initial setting)	OFF	<input type="radio"/>	
Yxy, XYZ	None (Initial setting)	OFF (Initial setting)	OFF (Initial setting)	ON (Initial setting)	<input type="radio"/>		
			ON	ON (Initial setting)	<input type="radio"/>		
		ON	OFF (Initial setting)	OFF	ON (Initial setting)	<input type="radio"/>	
			ON	ON (Initial setting)	OFF	<input type="radio"/>	
			ON	OFF	ON (Initial setting)	<input type="radio"/>	
			ON	ON (Initial setting)	OFF	<input type="radio"/>	
	Other than None	OFF (Initial setting)	OFF (Initial setting)	ON (Initial setting)	<input type="radio"/>		
			ON	ON (Initial setting)	<input type="radio"/>		
		ON	OFF (Initial setting)	OFF	ON (Initial setting)	<input type="radio"/>	
			ON	ON (Initial setting)	OFF	<input type="radio"/>	
			ON	OFF	ON (Initial setting)	<input type="radio"/>	
			ON	ON (Initial setting)	OFF	<input type="radio"/>	
Munsell (C), Munsell (D65), Gardner, Hazen/APHA, Iodine, Ph.EU, US Pharmacopoeia	None (Initial setting)	OFF (Initial setting)	OFF (Initial setting)	ON (Initial setting)	<input type="radio"/>		
			ON	ON (Initial setting)	<input type="radio"/>		
		ON	OFF (Initial setting)	OFF	ON (Initial setting)	<input type="radio"/>	
			ON	ON (Initial setting)	OFF	<input type="radio"/>	
	Other than None	OFF (Initial setting)	OFF (Initial setting)	ON (Initial setting)	<input type="radio"/>		
			ON	ON (Initial setting)	<input type="radio"/>		
		ON	OFF (Initial setting)	OFF	ON (Initial setting)	<input type="radio"/>	
			ON	ON (Initial setting)	OFF	<input type="radio"/>	

Sample Data Operation

On the <Sample Data Function> screen, the following operations are available for the sample data.

“Current” tab

- Save : Saves the current sample data to a USB memory device.
- Statistics : Performs statistical calculations using multiple samples selected in a list screen.
- Edit Name : Name the current sample data.
- Print : Print the current sample data.
- Delete : Delete the current sample data.
- Sample=>Target : Set sample data as target color data.

“All” tab

- Save : Save multiple sample data onto a USB memory device. This option can be selected only when a USB memory device is connected.
- Auto Target : Automatically select a target color with the smallest color difference for measurement.
- Delete All : Delete all sample data.

[Operating Procedure]

1. From the <Sample> detail screen, press the [OK/Edit] button.

The <Sample Data Function> screen is displayed.

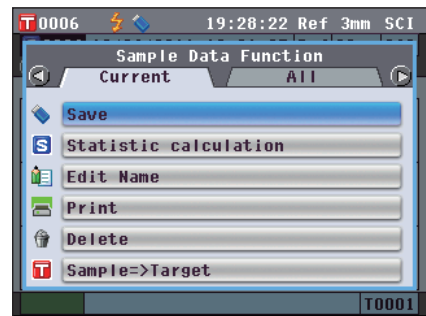

2. Use the ◀ or ▶ button of the cross key to change the tab, use the ▲ or ▼ button to move the cursor to an item to select or execute, and then press the [OK/Edit] button.

The setting screen for the selected item is displayed. For the operating procedure of each item, refer to the following sections.

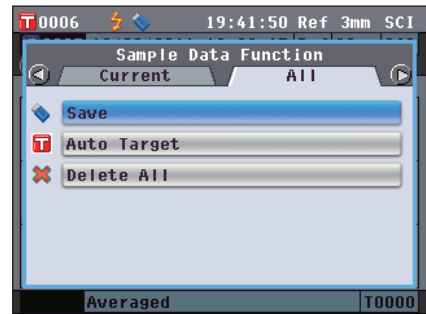

3. To return to the <Sample> detail screen, press the [Back] button while the <Sample Data Function> screen is displayed.

Sample	
10°/D65	
L*	74.96
a*	41.19
b*	71.53

Saving the Current Sample Data to a USB Memory Device

Save the current sample data to a USB memory device.

The USB memory device must be connected to the instrument before saving the data. For information on connecting a USB memory device, refer to page 141 “Connecting a USB Memory”.

[Operating Procedure]

Start the procedure from the <Sample Data Function> screen

2. Use the ◀ or ▶ button of the cross key to select the “Current” tab, use the ▲ or ▼ button to move the cursor to “Save”, and then press the [OK/Edit] button.

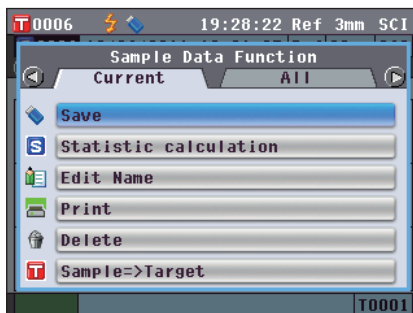

3. The <Save Sample Data> screen is displayed with a suggested file name shown.

To change the file name, use the ▲ or ▼ button of the cross key to move the cursor to the current file name and then press the [OK/Edit] button.



4. The <Edit File Name > screen is displayed.

Use the ▲ and ▼ buttons of the cross key to move the cursor around the characters and then press the [OK/Edit] button.

The selected character is added to the text box.

Memo A USB keyboard can also be used to input file names. For information on connecting a USB keyboard, refer to page 143 “Connecting a USB Keyboard”.

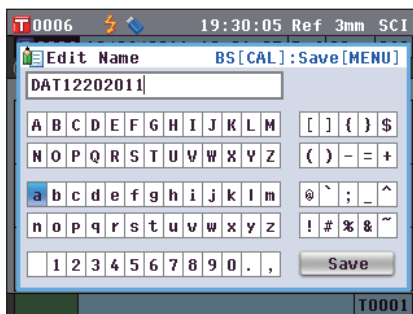

5. Repeat Step 3 until you have entered the necessary characters.
 - The position where characters will be added can be changed by using the ▲ or ▼ button of the cross key to position the cursor in the text box. The file name will then be modified at the position of the cursor.
 - To delete the character to the left of the cursor in the text box, press the [CAL] button.
 - The file name can be up to 20 characters long.

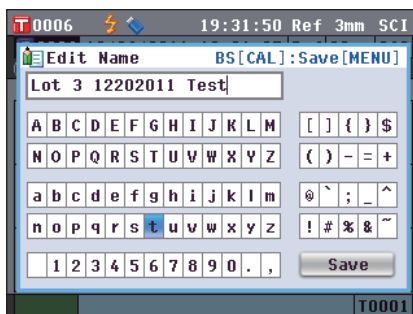

6. When you are finished entering characters, press [MENU] button, move the cursor to “Save” and then press the [OK/Edit] button.

The settings are confirmed and the screen returns to the <Save Sample Data> screen.

- Memo**
- If you press the [Back] button during the setting, “Do you want to save the changes?” is displayed. If you then place the cursor on “OK” and press the [OK/Edit] button, the setting details are confirmed and the screen returns to the <Save Sample Data> screen; if you place the cursor on “Cancel” and press the [OK/Edit] button, the setting details are not changed and the screen returns to the <Save Sample Data> screen.
 - Disconnect any USB keyboards connected to the instrument.

7. Connect the USB memory device. To accept the displayed file name, use the ▲ or ▼ button of the cross key to move the cursor to  and then press the [OK/Edit] button.

The <Saving...> screen is displayed.

When the saving is complete, the screen returns to the <Sample> detail screen.

- Memo**
- When the file format is set to the CM-S100w format, measured color difference data is saved along with set values. For details regarding file format settings, refer to page 141.

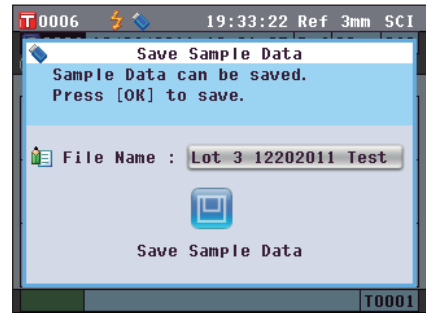

Performing Statistical Calculations on Sample Data

Performs statistical data on sample data stored in the instrument. The data to be used for calculations can be selected in a list screen. After calculations have been performed, the average of the samples selected for statistical calculations can be saved as a new sample data.

- Use the **Left** or **Right** button of the cross key to select the “Current” tab, use the **Up** or **Down** button to move the cursor to “Statistic calculation”, and then press the [OK/Edit] button.

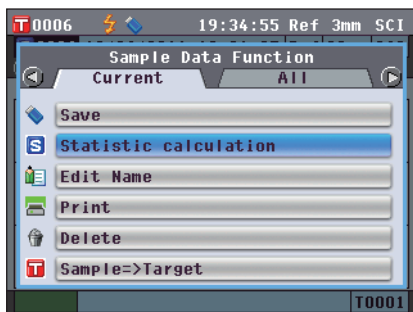

- The <Sample List> screen will appear.



- Use the **Up** or **Down** button of the cross key to select a sample to use for statistical calculations and then press the [OK/Edit] button to confirm the selection.

- A check mark will appear in the box to the left of the sample name when a sample is selected.
- Statistics can be performed using only samples measured under the same measurement conditions (measurement type, measurement area, SCI/SCE setting, linked target).
- To deselect a sample with a check mark, move the cursor to the sample and then press the [OK/Edit] button again.
- To select all samples shown on the screen, use the **Up** or **Down** button of the cross key to move the cursor to the “Page” button and then press the [OK/Edit] button. Check marks will appear to the left of all samples shown.
- Use the **Left** or **Right** button of the cross key to move to other pages in instrument memory. Selected data will remain selected even if pages are changed.



- After all desired samples have been selected, use the **Up** or **Down** button of the cross key to move the cursor to the “OK” button and then press the [OK/Edit] button.

The <Statistic calculation> screen will appear.

- To save the average of the data as a new sample, use the **Left** or **Right** button of the cross key to move the cursor to the [Save] button and press the [OK/Edit] button. The new data will be saved under the name “Averaged” and the <Statistic calculation> screen will close.
- To exit the <Statistic calculation> screen without saving, use the **Left** or **Right** button of the cross key to move the cursor to the [Cancel] button and press the [OK/Edit] button. The screen will return to the <Sample List> screen.

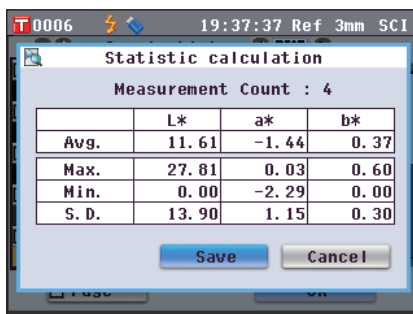

Edit Name

Name the sample data.

[Operating Procedure]

Start the procedure from the <Sample Data Function> screen.

1. Use the **◀** or **▶** button of the cross key to select the “Current” tab, use the **▲** or **▼** button to move the cursor to “Edit Name” and then press the [OK/Edit] button.

The <Edit Name> screen is displayed.

[Memo] A USB keyboard can also be used to input names for sample data. For information on connecting a USB keyboard, refer to page 143 “Connecting a USB Keyboard”.

2. Use **◀** and **▶** or **▲** and **▼** buttons of the cross key to move the cursor around the characters and then press the [OK/Edit] button.

- Up to 20 characters can be used.
- The selected character is displayed in the text box.

3. Repeat Step 2 until you have entered the necessary characters.

- You can use the **▲** or **▼** button of the cross key to move the blue box cursor on the text box.
In this status, you can move the character position and modify the character by pressing the **◀** or **▶** button of the cross key.
- To delete the character to the left of the cursor in the text box, press the [CAL] button.

4. When you finish entering characters, press [MENU] button, move the cursor to “Save”, and then press the [OK/Edit] button.

The setting is confirmed and the screen returns to the <Sample> detail screen.

[Memo] If you press the [Back] button during the setting, “Do you want to save the changes?” is displayed. When you place the cursor on “OK” and press the [OK/Edit] button, the setting details are confirmed and the screen returns to the <Sample> detail screen. When you place the cursor on “Cancel” and press the [OK/Edit] button, the setting details are not changed and the screen returns to the <Sample> detail screen.

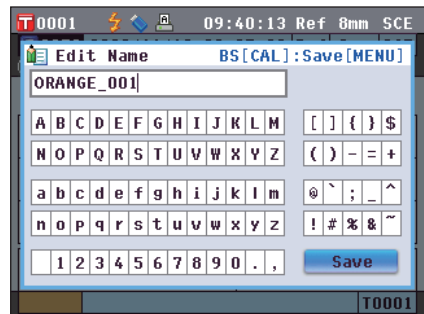
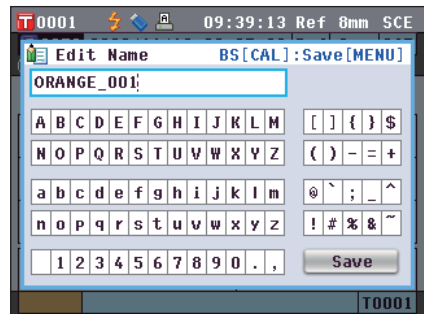
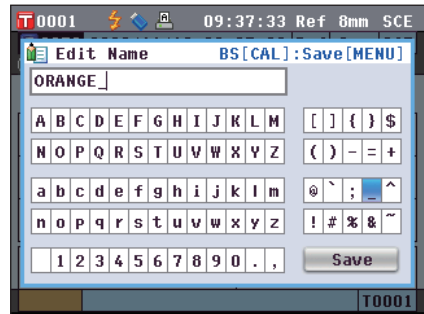
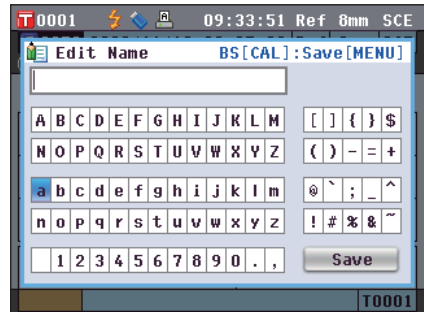

Print

Print the sample data.

You need to connect the instrument to a serial printer in advance. For instructions on how to connect the instrument and a serial printer, refer to page 145 “Printer Connection”.

- Notes**
- If proper connection is not established, you cannot print data.
 - Even if the connection has been correctly established, printing may fail for reasons such as the printer being turned off when printing is attempted.

[Operating Procedure]

Start the procedure from the <Sample Data Functions> screen.

1. Use the \leftarrow or \rightarrow button of the cross key to select the “Current” tab, and then use the \uparrow or \downarrow button to move the cursor to “Print”.

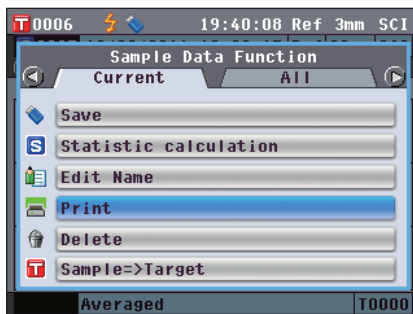

2. Press the [OK/Edit] button. The <Print Sample Data> screen is displayed and the data is printed out from the connected printer.

When the printing is complete, the screen returns to the <Sample> detail screen.

- Notes** The <Print Sample Data> screen is displayed even when data will not be printed properly due to an improper printer connection or other problems.

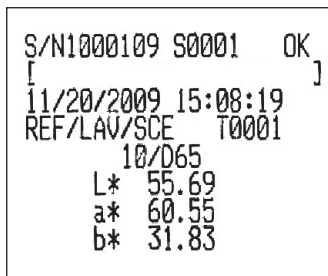

Delete

Delete the sample data.

[Operating Procedure]

Start the procedure from the <Sample Data Functions> screen.

1. Use the or button of the cross key to select the “Current” tab, use the or button to move the cursor to “Delete” and then press the [OK/Edit] button. The <Delete Sample Data> screen is displayed.

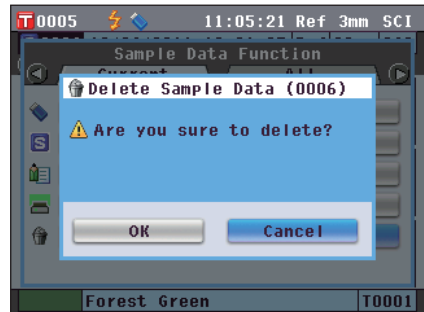
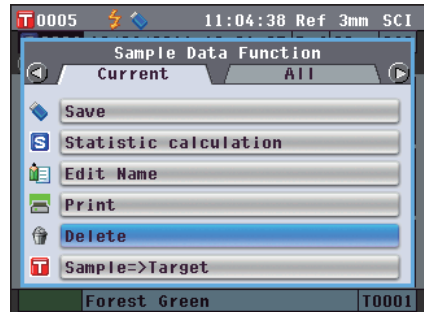

2. Use the button of the cross key to move the cursor to “OK” and press the [OK/Edit] button. The data is deleted.

Memo When data is deleted, the subsequent sample data Nos. will be reassigned, reducing them by one.

- When the deletion is complete, the screen returns to the <Sample> detail screen.
- When you place the cursor on “Cancel” and press the [OK/Edit] button, the deletion is canceled and the screen returns to the <Sample> detail screen.

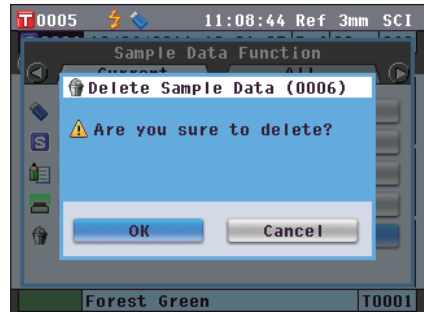

Parameter	Value
L*	68.03
C*	56.73
h	110.72





Sample=>Target

Set sample data as target color data.



[Operating Procedure]

Start the procedure from the <Sample Data Function> screen.

Notes Unlike measured data, the numbers assigned to target color data do not change automatically. When you measure colors continuously to set target colors, you need to move the cursor manually to set each data.

1. Use the  or  button of the cross key to select the “Current” tab, use the  or  button to move the cursor to “Sample=>Target”, and then press the [OK/Edit] button.

The “Target List” screen appears.

2. The target color data number being used will be highlighted. Use the  or  button of the cross key to move to a desired target color No., and then press the [OK/Edit] button. When the target color data is set, the screen returns to the <Sample> screen.

Notes If you selected a number to which target color data has already been set, a message is displayed to confirm overwriting.

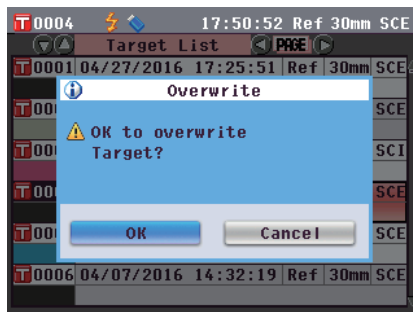
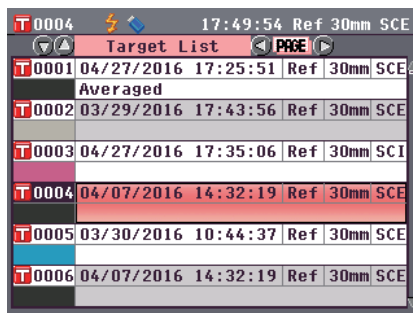
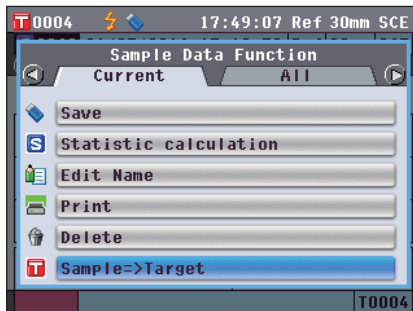

Saving Data onto a USB Memory Device

Save sample data stored in the instrument onto the USB memory device.

You need to connect a USB memory device to the instrument in advance. For the connection of a USB memory device, refer to page 141 “Connecting a USB Memory”.

[Operating Procedure]

Start the procedure from the <Sample Data Function> screen.

1. Use the **◀** or **▶** button of the cross key to select the “All” tab, use the **▲** or **▼** button to move the cursor to “Save”, and then press the [OK/Edit] button.

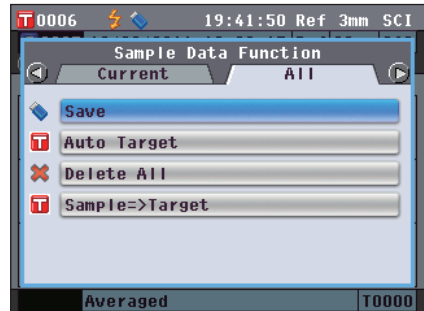

2. The <Sample List > screen appears, with all samples initially selected (check marks shown in the box to the left of the sample name).
 - To deselect a sample with a check mark, move the cursor to the sample and then press the [OK/Edit] button.
 - To deselect all samples shown on the screen, use the **▲** or **▼** button of the cross key to move the cursor to the “Page” button and then press the [OK/Edit] button. The check marks to the left of all samples shown will disappear.
 - Use the **◀** or **▶** button of the cross key to move to other pages in instrument memory. Selected data will remain selected even if pages are changed.



3. When selection/deselection of samples has been completed, use the **▲** or **▼** button of the cross key to move the cursor to the “Save” button and then press the [OK/Edit] button.





The <Save Sample Data> screen is displayed with a suggested file name shown.



4. To change the file name, use the **▲** or **▼** button of the cross key to move the cursor to “File Name” and then press the [OK/Edit] button.



The <Edit Name> screen is displayed.



5. Use the  or  and  or  buttons of the cross key to move the cursor around the characters and then press the [OK/Edit] button.

The selected character is added to the text box.

6. Repeat Step 5 until you have entered the necessary characters.



- The position where characters will be added can be changed by using the  or  button of the cross key to position the cursor in the text box. The file name will then be modified at the position of the cursor.
- To delete the character to the left of the cursor in the text box, press the [CAL] button.
- The file name can be up to 20 characters long.

Memo A USB keyboard can also be used to input file names. For information on connecting a USB keyboard, refer to page 143 “Connecting a USB Keyboard”.

7. When you are finished entering characters, press [MENU] button, to move the cursor to “Save” and then press the [OK/Edit] button.

The settings are confirmed and the screen returns to the <Save Sample Data> screen.

Memo If you press the [Back] button during the setting, “Do you want to save the changes?” is displayed. When you place the cursor on “OK” and press the [OK/Edit] button, the setting details are confirmed and the screen returns to the <Save Sample Data> screen. When you place the cursor on “Cancel” and press the [OK/Edit] button, the setting details are not changed and the screen returns to the <Save Sample Data> screen.

8. To accept the displayed file name, use the  or  button of the cross key to move the cursor to  “Save Sample Data” and then press the [OK/Edit] button.

- The <Saving...> screen is displayed.
- When the saving is complete, the screen returns to the <Sample> detail screen.

Memo When the file format is set to the CM-S100w format, measured color difference data is saved along with set values. For details regarding file format settings, refer to page 141.

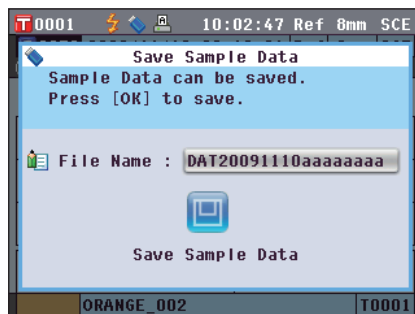
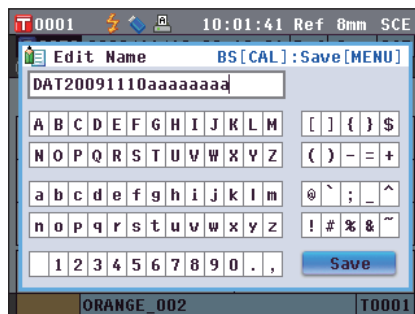
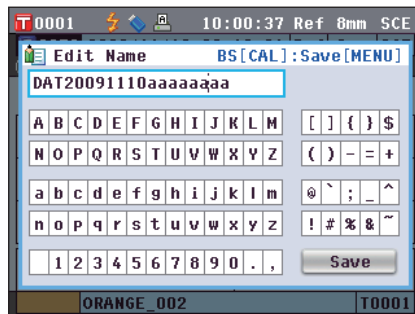
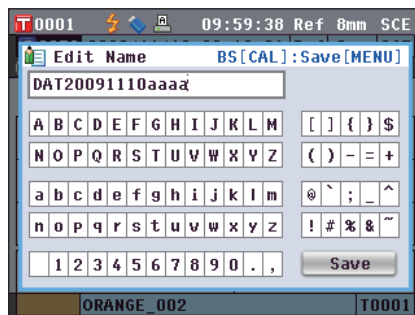

Auto Target

Use this function to automatically select the target color with the smallest color difference (ΔE^*ab) for measurement.

Memo The target color will be selected from those with the same specular component mode and other measurement condition settings for the measurement.

- Notes**
- Do not use this function if you want to control the color difference from a specific target color.
 - This setting will not be applied to the sample data obtained before this function was set to ON.

[Setting Procedure]

Start the procedure from the <Sample Data Function> screen.

1. Use the \leftarrow or \rightarrow button of the cross key to select the "All" tab, use the \uparrow or \downarrow button to move the cursor to "Auto Target" and then press the [OK/Edit] button. The <Auto Target> screen is displayed.

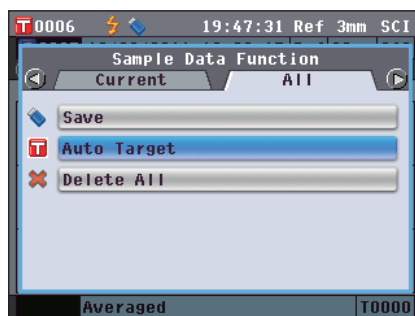

2. Use the \uparrow or \downarrow button of the cross key to move the cursor to "ON" or "OFF".

Settings

- ON: Use the Auto Target function for measurement.
- OFF: Do not use the Auto Target function.

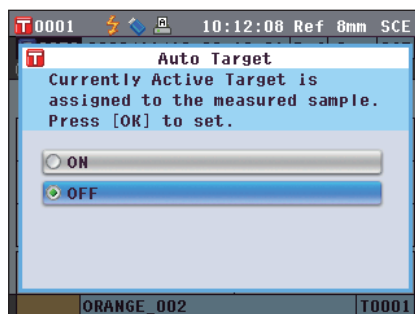

3. Press the [OK/Edit] button.

The selection is confirmed and the screen returns to the <Sample> detail screen.

Notes If you press the [Back] button without pressing the [OK/Edit] button, you return to the <Sample> detail screen without changing the setting.

Sample	
10°/D65	
L*	74.98
C*	41.13
h	71.56

Delete All

Delete all sample data.

[Operating Procedure]

Start the procedure from the <Sample Data Functions> screen.

1. Use the ◀ or ▶ button of the cross key to select the “All” tab, use the ▲ or ▼ button to move the cursor to “Delete All” and then press the [OK/Edit] button.
The <Delete All Samples> screen is displayed.

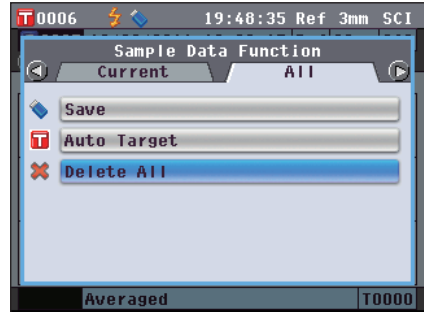

2. Use the ◀ button of the cross key to move the cursor to “OK” and press the [OK/Edit] button. All data is deleted.
 - When the deletion is complete, the screen returns to the <Sample> detail screen.
 - When you place the cursor on “Cancel” and press the [OK/Edit] button, the deletion of all data is canceled and the screen returns to the <Sample> detail screen.

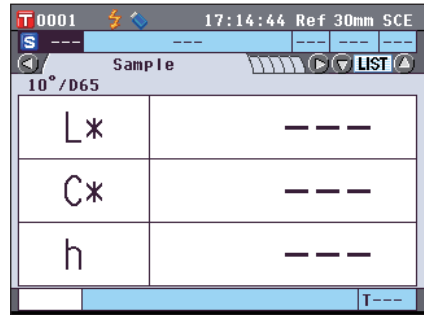

Average Measurement

When taking measurements or setting target colors, more accurate data can be obtained if the averaging function is used.

With the CM-5, the following two averaging functions are available.

- **Manual Measurement** : When the color of the specimen is not uniform, measurements are performed randomly at different positions on the specimen and then the average of the measured spectral reflectance/transmittance data is calculated. This gives the average data of the entire specimen.
- **Auto Measurement** : The specified number of measurements are repeated at the same position on the specimen and then the average of the measured spectral reflectance/transmittance data is calculated. This will improve the accuracy of the sample data.

These two averaging functions can also be used in combination. In this case, it is necessary to make settings for both auto and manual averaging. For details, refer to page 64 “Auto Measurement” and page 65 “Manual Measurement”.

Notes For average measurement, the average of the spectral reflectance/transmittance values of the sample data is calculated first, and then colorimetric value is calculated based on that calculated average. Thus, the result may not match the average of the colorimetric values of the sample data.

Manual Measurement

This method is used when the color of the specimen is not uniform. Measurements are performed randomly at different positions on the specimen and then the average of the measured spectral reflectance/transmittance data is calculated, to obtain the average data of the entire specimen.

- Notes**
- Before using manual averaging, you must complete the settings for manual averaging. For details, refer to page 65 “Manual Measurement”.
 - To print individual measurement results (sample data) before averaging, connect the printer to the instrument before measuring. For information on connecting the printer, refer to page 145 “Printer Connection”. Please note that the sample data before averaging is saved in the instrument.

[Operating Procedure]

1. **When a screen other than the <Sample> screen is displayed, press the [Target/Sample] button.**
 - The <Sample> screen is displayed.
 - Every time the [Detail/List] button is pressed, the screen is switched between the <Sample> detail screen and <Sample> list screen.

Memo Measurement can be performed on either the <Sample> detail screen or <Sample> list screen.

2. **Set the specimen on the Target Mask or Transmittance Specimen Chamber according to the measurement type.**

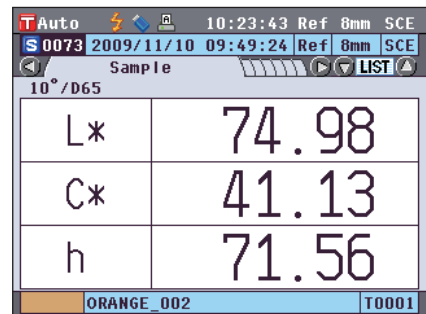

T Auto 10:23:43 Ref 8mm SCE	
S 0073 2009/11/10 09:49:24 Ref 8mm SCE	
Sample LIST	
10°/D65	
L*	74.98
C*	41.13
h	71.56
ORANGE_002 T0001	

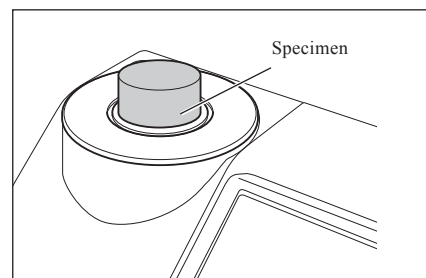





3. Make sure that  (Ready to measure) is displayed and then press the measuring button.

The specimen is measured and the <Manual Average Measurement> screen is displayed.

The <Manual Average Measurement> screen shows the result of the statistic calculation using the sample data of the measurements performed so far.

Memo

- If you use the  or  button of the cross key to select “Finish” and press the [OK/Edit] button, you can finish the manual averaging before the specified number of measurements is completed and the averaging result of the measurements performed so far is added to the <Sample> screen as new sample data.
- If you use the  or  button of the cross key to move the cursor to “Cancel” and press the [OK/Edit] button, you can cancel the manual averaging.

4. Place the specimen at the next measuring position and repeat the steps from 1 to 3.

When the specified number of measurements has been completed, the final result of the statistic calculation will be shown. Check that “Finish” is selected and press the [OK/Edit] button. The averaging result will be displayed on the <Sample> screen as new sample data.

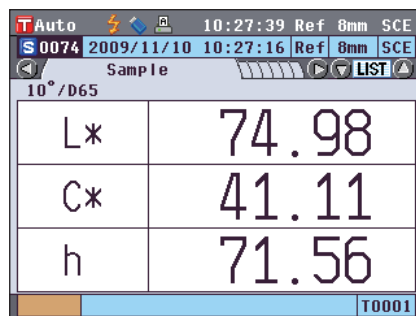

Auto Measurement

Measurement is repeated the specified number of times at the same position on the specimen and then the average of the measured spectral reflectance/transmittance data is calculated. This will improve the accuracy of the sample data.

Notes Before starting auto averaging, you must complete the settings for auto averaging. For details, refer to page 64 “Auto Measurement”.

[Operating Procedure]

1. When a screen other than the <Sample> screen is displayed, press the [Target/Sample] button. The <Sample> screen is displayed.
 - Every time the [Detail/List] button is pressed, the screen is switched between the <Sample> detail screen and <Sample> list screen.

Memo Measurement can be performed on either the <Sample> detail screen or <Sample> list screen.
2. Set the specimen on the Target Mask or Transmittance Specimen Chamber according to the measurement type.

T Auto 10:29:44 Ref 8mm SCE	
S 0074 2009/11/10 10:27:16 Ref 8mm SCE	
Sample LIST	
10°/D65	
L*	74.98
C*	41.11
h	71.56
T0001	

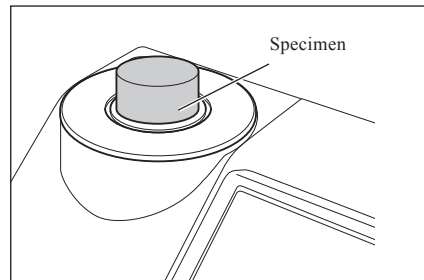

3. Make sure that  (Ready to measure) is displayed and then press the [MEAS] button. The number of completed measurements will be displayed during measurement.

Notes You cannot cancel the auto averaging in progress.

When the specified number of measurements has been completed, the averaging result will be displayed on the <Sample> screen as new sample data.

Chapter 4

Other Functions

Pass/Fail Judgment for Color Difference

With the CM-5, you can set tolerances for the color difference of the sample data from the target color data to make pass/fail judgment.

For the procedure of setting tolerances, refer to page 85 “Tolerance Setting” and page 89 “Default Tolerance Setting”.

The pass/fail judgment will be based on the target color data of the number selected for measurement, and on the tolerance data specified for that target color data.

If target color data is deleted, neither the color difference display for the data nor the pass/fail judgment based on the tolerances set to the data will be performed. Even if other target color data is selected, recalculations and pass/fail judgments will not take place. If, however, another target color is assigned to the target color No. of the deleted data, recalculations and pass/fail judgments will be performed.

Pass/Fail Judgment Based on Tolerances

If the measured color difference is outside the tolerances set for the target color, the value will be highlighted in red to indicate that the judgment result is “Fail”. Both + and - tolerances can be set for each target color.

To perform pass/fail judgment based on tolerances, follow the procedure given below.

Notes Before using this function, you must set color difference tolerances.

[Operating Procedure]

1. Press the [TARGET/SAMPLE] button on the <Sample> screen.

The <Target> screen is displayed.

- Every time the [Detail/List] button is pressed, the screen is switched between the <Target> detail screen and <Target> list screen.

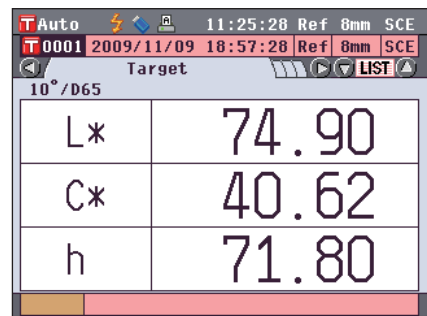

Target	
L*	74.90
C*	40.62
h	71.80

2. Use the ▲ or ▼ button of the cross key to select the target color No.

In the list, you can press the ◀ or ▶ button of the cross key to change the screen entirely to the next screen.

Memo The next step is to confirm the color difference tolerance settings. If this confirmation is unnecessary, go to step 6.

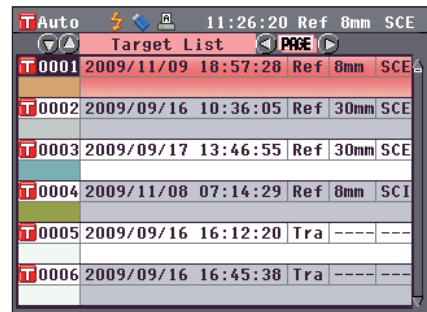

Target No.	Date	Time	Ref	mm	SCE
T0001	2009/11/09	18:57:28	Ref	8mm	SCE
T0002	2009/09/16	10:36:05	Ref	30mm	SCE
T0003	2009/09/17	13:46:55	Ref	30mm	SCE
T0004	2009/11/08	07:14:29	Ref	8mm	SCI
T0005	2009/09/16	16:12:20	Tra	----	----
T0006	2009/09/16	16:45:38	Tra	----	----

3. On the <Target> detail screen, press the [OK/Edit] button.

The <Target Data Function> screen is displayed.

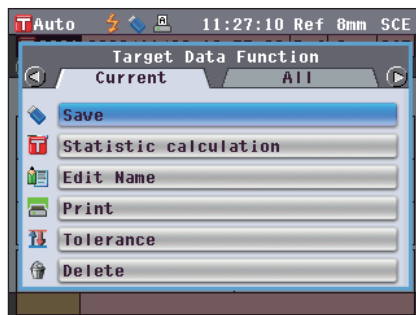

4. Use the ◀ or ▶ button of the cross key to select the “Current” tab, use the ▲ or ▼ button to move the cursor to “Tolerance”, and then press the [OK/Edit] button.

The <Tolerance> screen is displayed.

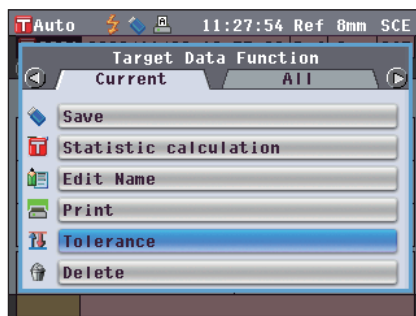

5. Make sure that the values are set properly, and then press the [Back] button twice.

The <Target> screen is displayed.



6. Press the [Target/Sample] button.

The <Sample> screen is displayed.

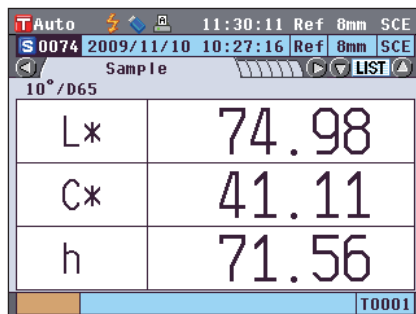

7. Set the specimen on the Target Mask or Transmittance Specimen Chamber according to the measurement type, and press the [MEAS] button.

The specimen is measured and the results are displayed on the screen.

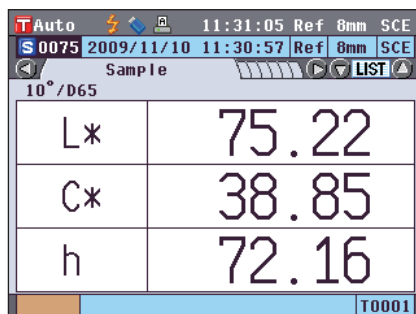

<Sample> detail screen: “Difference” tab or “Abs. & Diff.” tab

- ① The values which failed the judgment are highlighted in red. In the print output to the printer, “X” is appended after the failed item.

T Auto 11:32:28 Ref 8mm SCE			
S 0075 2009/11/10 11:30:57 Ref 8mm SCE			
Difference LIST			
ΔL^*	0.32		
ΔC^*	-1.77		
ΔH^*	0.25		
ΔE^*_{94}	0.72		10°/D65
			Fail
T0001			

T Auto 11:33:20 Ref 8mm SCE				
S 0075 2009/11/10 11:30:57 Ref 8mm SCE				
Abs. & Diff. LIST				
10°/D65	L*	C*	h	
Target	74.90	40.62	71.80	
Sample	75.22	38.85	72.16	
Diff.	0.32	-1.77	0.25	
	ΔE^*_{94}	0.72		
10°/D65	L*	C*	h	MI
Target	74.90	40.62	71.80	0.00
Sample	75.22	38.85	72.16	
Diff.	0.32	-1.77	0.25	
	ΔE^*_{94}	0.72		Fail
T0001				

- ② When at least one item failed the judgment, “Fail” is displayed; when all items passed the judgment, “Pass” is displayed. In the print output to the printer, “OK” is printed when the judgment result is “Pass”, and “NG” is printed when the judgment result is “Fail”.

T Auto 11:31:31 Ref 8mm SCE			
S 0076 2009/11/10 11:34:22 Ref 8mm SCE			
Difference LIST			
ΔL^*	0.34		
ΔC^*	0.29		
ΔH^*	-0.06		
ΔE^*_{94}	0.35		10°/D65
			Pass
T0001			

- Memo**
- “Pass” will be displayed only when all the items have passed the judgment.
 - When no target color data has been set, when the target color data of the number selected for the measurement has been deleted, or when all tolerance settings are OFF, “None” will be displayed instead of the judgment results.

Connecting to an External Device

The instrument features two USB connection terminals, one for connecting a USB memory or a USB keyboard and one for connecting a PC, and an RS-232C connector. USB memory can be used for saving data or various conditions, and a USB keyboard can be used for text input when editing sample data names. Moreover, the supplied USB cable (IF-A19) can be used to connect the instrument to a PC to transmit data.

- Notes**
- Only use the prescribed equipment and cables with the two types of USB cables and RS-232C connector.
 - When the instrument is exposed to strong external static electricity or is affected by ambient interference during communication with an external device, the communication may be interrupted. In this case, turn the power OFF and then turn it ON again.

Connecting a USB Memory

You can save the conditions, sample data, and target color data stored in the memory of the instrument into a USB memory as a file. You can load this condition file from the USB memory to the instrument and set the conditions all at once.

- Notes**
- USB memory devices with no security features are supported.
 - Make sure that the USB memory is oriented correctly and connected securely.
 - To connect the USB memory, check the shape of the receptacle (connection terminal) and insert the connector fully until it is secured.

Memo The USB connection terminal of the instrument conforms to USB 1.1.

[Operating Procedure]

A USB memory can be connected or disconnected even while the instrument is turned ON.

1. Connect the USB memory to the USB connection terminal (A type).

Fully insert the connector and ensure that it is connected securely.

When the USB memory is properly connected,  (USB memory connected) is displayed on the screen.

Memo Disconnect any USB keyboards to connect a USB memory device.

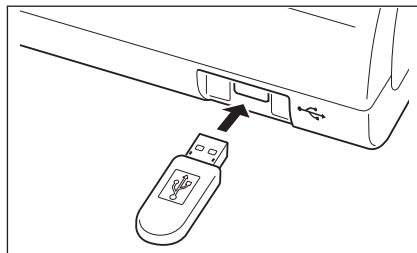

Setting the File Format





Set the format of the sample data file or target color data file to be saved into the USB memory.

[Operating Procedure]

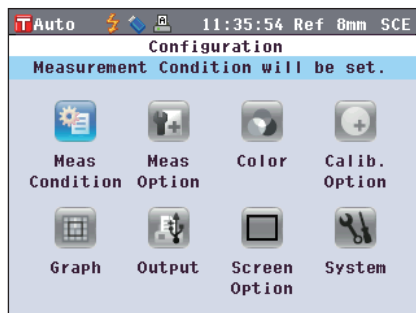
1. Press the [MENU] button.



The <Configuration> screen is displayed.

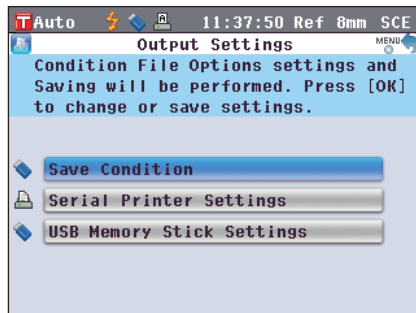

- Use the  or  and  or  buttons of the cross key to move the cursor to “Output” and then press the [OK/Edit] button.

The <Output Settings> screen is displayed.



- Use the  or  button of the cross key to move the cursor to “USB Memory Stick Settings” and then press the [OK/Edit] button.

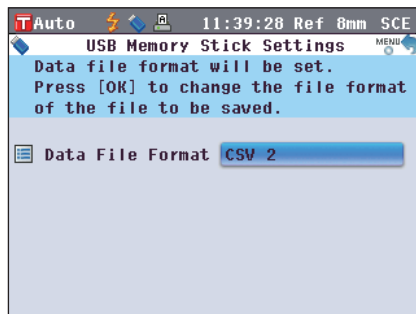

The <USB Memory Stick Settings> screen is displayed with a currently-specified file format.

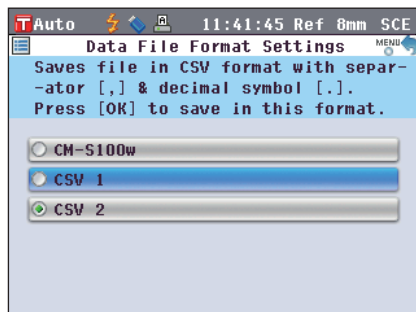

- To change the file format, press the [OK/Edit] button.

The <Data File Format Settings> screen is displayed.



- Use the  or  button of the cross key to move the cursor to the desired item.

Settings

- CM-S100w:

Binary format which can be read with the optional Color Management Software SpectraMagic™ NX

- CSV1:

CSV format using “,” for a separator and “.” for a decimal point.

- CSV2:

CSV format using “;” for a separator and “.” for a decimal point.

- Press the [OK/Edit] button.

The selection is confirmed and the screen returns to the <USB Memory Stick Settings> screen.

Notes If you press the [Back] button without pressing the [OK/Edit] button, you return to the <USB Memory Stick Settings> screen without changing the setting.

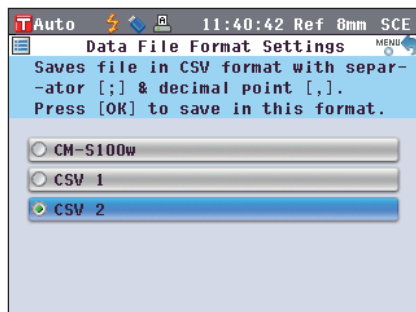

- Press the [Back] button twice to return to the <Sample> screen.

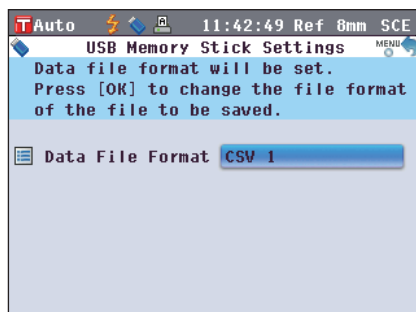

Connecting a USB Keyboard

On the <Sample Data Function> screen, a USB keyboard can be used for text input when editing sample data names.

- Notes**
- Make sure that the USB keyboard is oriented correctly and connected securely.
 - To connect the USB keyboard, check the shape of the receptacle (connection terminal) and insert the connector fully until it is secured.

Memo This instrument is compatible with USB human interface device class US layout keyboards. (Operation is not guaranteed for all of the above supported USB keyboards.)

[Operating Procedure]

A USB keyboard can be connected or disconnected even while the instrument is turned ON.

1. Connect the USB keyboard to the USB connection terminal (A type).

Fully insert the connector and ensure that it is connected securely.

Memo Disconnect any USB memory devices to connect a USB keyboard.

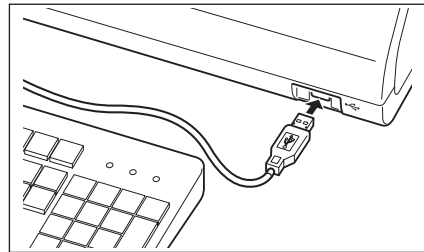

About US Keyboard Layout

Use the keys shown within the border below to enter text.

[Standard]



[Shift +]



Connecting a Personal Computer

Connect the instrument to a PC with the supplied USB cable IF-A19 (2 m).

- Memo**
- When connected to a PC, the instrument enters the communication mode automatically. The LCD screen displays “Communicating” and the measuring and control buttons are disabled.
 - If remote measurement from a PC using the optional Color Management Software SpectraMagic™ NX is configured for the instrument, it will be possible to measure by pressing the [MEAS] button on the instrument. In such cases, “Communicating” will be displayed on the screen title tab. However, because only the [MEAS] button is enabled at this time, switching display screens will not be possible. Also, sample data will be saved to the instrument memory as well as to the PC.
 - To connect the instrument with a PC, it is recommended that you use software that enables connection and operation of the instrument (such as the optional Color Management Software SpectraMagic™ NX).
 - The USB communication port of the instrument conforms to USB 1.1.

- Notes**
- To connect the instrument to a PC, you need to install the USB driver dedicated to the CM-5. Install the USB driver supplied with the software that enables connection and operation of the instrument.
 - The instrument is not designed to be powered via the USB cable. You need to connect the AC adapter.
 - Make sure that the USB connector plug is oriented correctly and connected securely.
 - When connecting/disconnecting the USB cable, be sure to hold the connector plug. Do not pull on or forcibly bend the cable. Otherwise, wire breakage may result.
 - Make sure that the cable has sufficient length. Putting tension on the cable may cause connection failure or wire breakage.
 - To connect the USB cable connector, check the shape of the receptacle (connection terminal) and insert the connector fully until it is secured.

[Operating Procedure]

In general, a USB cable can be connected/disconnected while the instrument is turned ON, however, you need to turn OFF the instrument in the procedure below.

1. **Turn OFF the instrument (Slide the Power switch to “O”).**

2. **Connect the B connector of the USB cable to the USB connection terminal (B type) of the instrument.**

- Fully insert the connector and ensure secure connection.

3. **Connect the A connector of the USB cable to the USB port of the PC.**

4. **Turn ON the instrument (Slide the Power switch to “I”).**

- When you are prompted to install the USB driver, specify the USB driver included with the software and complete the installation.

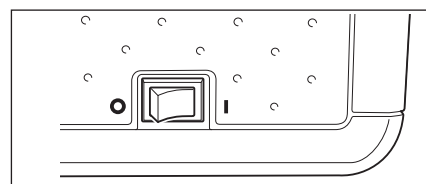
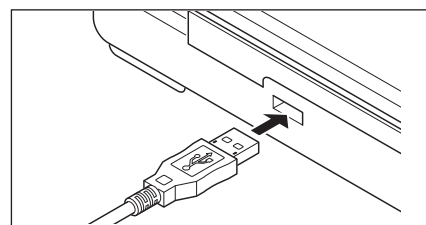
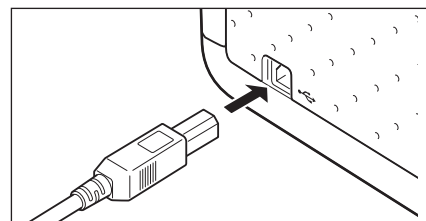
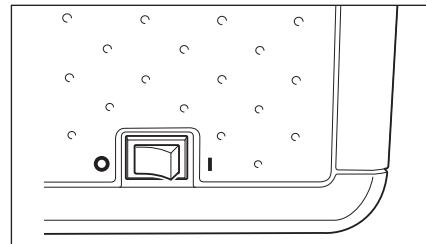

Printer Connection

By connecting the instrument to a serial printer with a connecting cable, you can print out the sample data and target color data stored in the memory of the instrument. You can use the “Automatic output” which prints data automatically for each measurement, or can print out the sample data and target color data currently displayed.

Memo Only text data can be output to a serial printer for printing. You cannot output the color difference graph or other graphs displayed on the instrument.

- Notes**
- Make sure that the connector is oriented correctly and connected securely. Using the screws to secure the connector prevents accidental disconnection.
 - Be sure to turn OFF the power of both the instrument and printer before connecting them.
 - To connect or disconnect the connecting cable, you must hold its plug or connector. Do not pull on or forcibly bend the cable.
 - Do not touch the connector terminals, make them dirty or apply a strong force on them.
 - Make sure that the cable has sufficient length. Putting tension on the cable may cause contact failure or wire breakage.
 - Connect the instrument and printer with a printer cable conforming to “○Pin No.-Signal Connection Diagram for Printer Cable”.

○Communication Parameters

Item	Communication condition
Baud rate	4800 bps, 9600 bps, 19200 bps
Character length	8 bits
Parity	None
Stop bit	1 bit
Flow control	RTS/CTS

○Applicable printer

Any printers which conform to the following specifications can be used.

Item	Communication condition
No. of printing lines	24 digits or more, Data input: RS-232C
Data control	BUSY
Baud rate	4800 bps, 9600 bps, 19200 bps
Character length	8 bits
Parity	None
Stop bit	1 bit
Basic function	CR (0DH) carriage return

○ Pin No.-Signal Connection Diagram for Printer Cable

- For a D-sub 9-pin connector

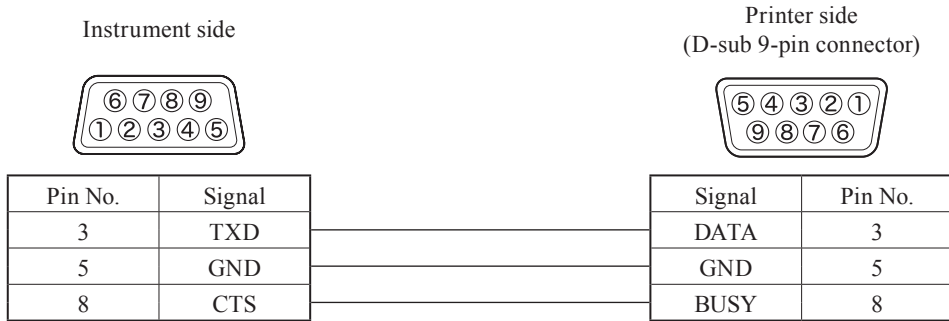

- For a D-sub 25-pin connector

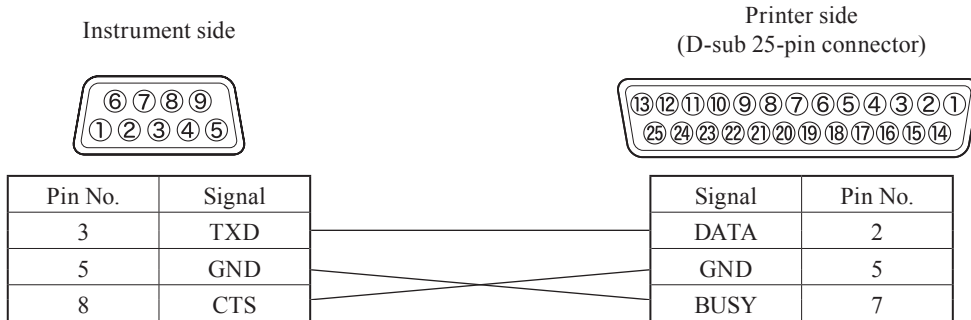

Setting the Communication Parameters

Set the communication parameters between the instrument and serial printer.

[Operating Procedure]

1. Press the [MENU] button.

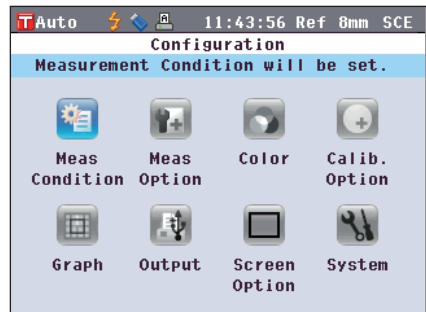

The <Configuration> screen is displayed.



2. Use the ◀ or ▶ and ▲ or ▼ buttons of the cross key to move the cursor to “Output” and then press the [OK/ Edit] button.

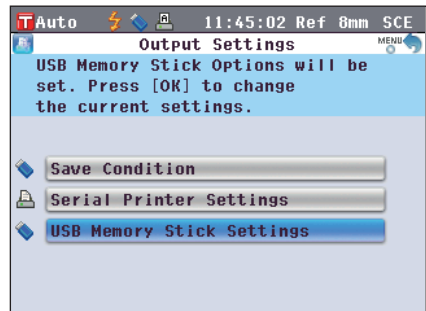

The <Output Settings> screen is displayed.



- Use the  or  button of the cross key to move the cursor to “Serial Printer Settings” and then press the [OK/Edit] button.

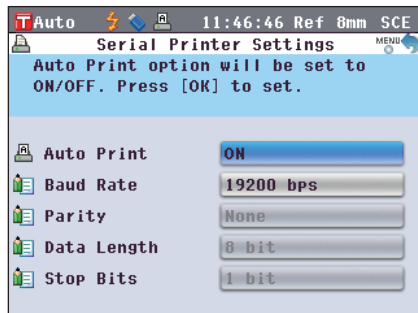

The <Serial Printer Settings> screen is displayed with a currently-specified baud rate. Other communication parameters cannot be changed.

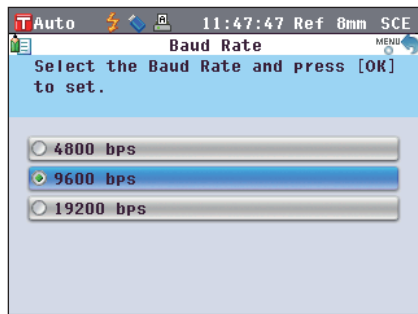

- To change the baud rate, use the  or  button of the cross key to move the cursor to “Baud Rate” and then press the [OK/Edit] button.

The <Baud Rate> screen is displayed.



- Use the  or  button of the cross key to move the cursor to the desired item.

Settings

- 4800 bps
- 9600 bps
- 19200 bps

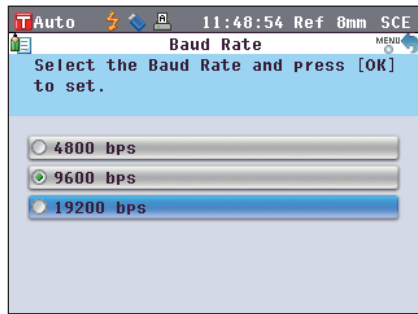

- Press the [OK/Edit] button.

The selection is confirmed and the screen returns to the <Serial Printer Settings> screen.

Notes If you press the [Back] button without pressing the [OK/Edit] button, you return to the <Serial Printer Settings> screen without changing the setting.

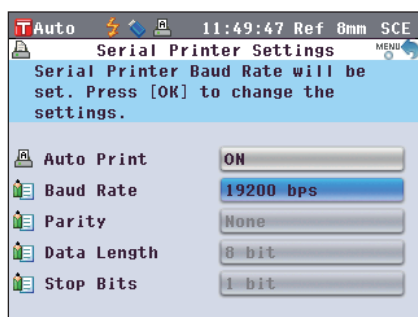

- Press the [Back] button three times to return to the <Sample> screen.

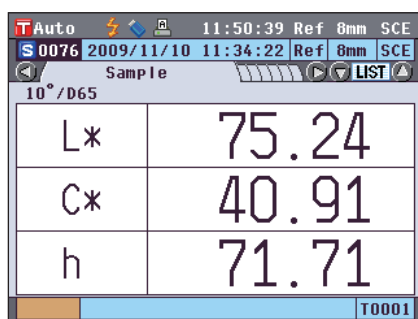

Printing Out Sample Data/Target Color Data

Print the sample data or target color data with the printer.
You need to connect the instrument to a serial printer in advance.

Memo Only text data can be output to a serial printer for printing. You cannot output the color difference graph or other graphs displayed on the instrument.

[Operating Procedure]

Start the procedure from the <Sample> detail screen or <Target> detail screen where a measurement result is displayed.

1. Press the [PRINT] button. The <Print Sample Data> or <Print Target Data> screen is displayed and the data is printed from the connected printer.

- When the printing is complete, the screen returns to the <Sample> detail screen or <Target> detail screen.

- Notes**
- The <Print Sample Data> or <Print Target Data> screen is displayed also for the case where printing will not be processed properly such as when the printer connection is incorrect.
 - On the <Sample> list screen or <Target> list screen, printing is disabled even when the measurement result is displayed on the screen.

Memo In addition to the procedure above, printing can be started on the <Sample Data Function> screen or <Target Data Function> screen. For the procedure, refer to page 127 “Sample Data Operation: Print” or page 84 “Color Difference Target Color Data Operation: Print”.

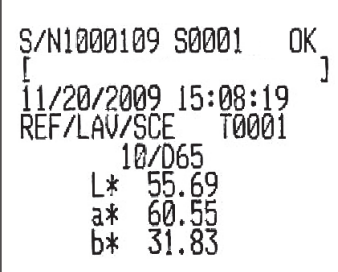

```
S/N1000109 S0001 OK
[
11/20/2009 15:08:19
REF/LAV/SCE T0001
10/D65
L* 55.69
a* 60.55
b* 31.83
```

Setting the Auto Print

When the Auto Print is set to ON, sample data or target color data is automatically printed on the printer for every measurement.





You need to connect the instrument to a serial printer in advance.

Memo Only text data can be output to a serial printer for printing. You cannot output the color difference graph or other graphs displayed on the instrument.

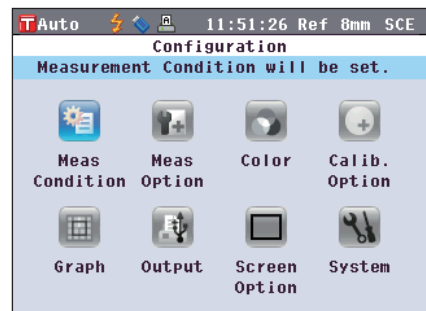
[Operating Procedure]



1. Press the [MENU] button.
The <Configuration> screen is displayed.



- Use the  or  and  or  buttons of the cross key to move the cursor to “Output” and then press the [OK/Edit] button.

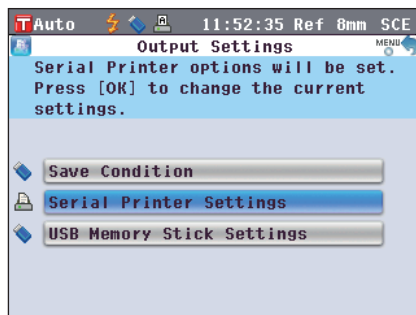

The <Output Settings> screen is displayed.



- Use the  or  button of the cross key to move the cursor to “Serial Printer Settings” and then press the [OK/Edit] button.

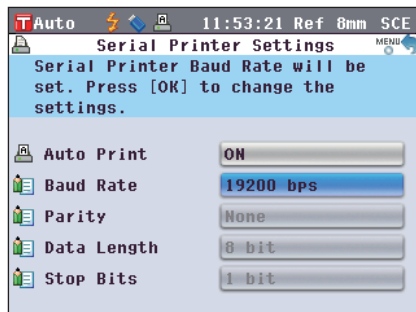

The <Serial Printer Settings> screen is displayed.

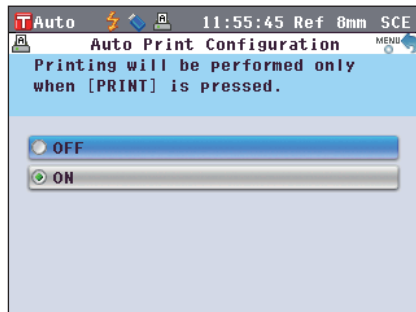

- Use the  or  button of the cross key to move the cursor to “Auto Print” and then press the [OK/Edit] button.

The <Auto Print Configuration> screen is displayed.



- Use the  or  button of the cross key to move the cursor to the desired item.

Settings

○OFF: Disable Auto Print.

○ON: Enable Auto Print. The  (Auto Print ON) icon is displayed on the screen.

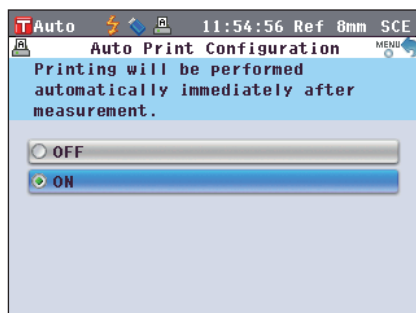

- Press the [OK/Edit] button.

The selection is confirmed and the screen returns to the <Serial Printer Settings> screen.

Notes If you press the [Back] button without pressing the [OK/Edit] button, you return to the <Serial Printer Settings> screen without changing the setting.

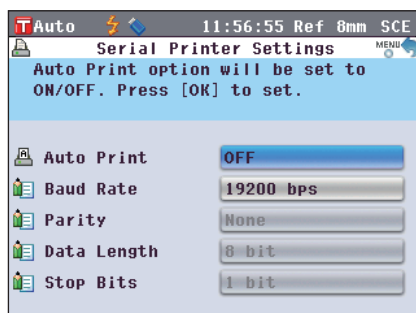

7. Press the [Back] button three times to return to the <Sample> screen.

L*	75.24
C*	40.91
h	71.71

T0001

After measurement is performed on either of the <Sample> detail screen or <Target> detail screen, the <Print Sample Data> or <Print Target Data> screen is displayed and the data is printed from the connected printer.

- Notes**
- The <Print Sample Data> or <Print Target Data> screen is displayed also for the case where printing will not be processed properly such as when the printer connection is incorrect.
 - On the <Sample> list screen or <Target> list screen, the data is not printed after measurement.

• **Print Example 1**

<Sample> detail screen: Absolute and Abs. Graph tab

L*	55.69	Sample	55.69	Target	55.59
a*	60.55	Sample	60.55	Target	60.51
b*	31.83	Sample	31.83	Target	31.82

Absolute value and pass/fail Judgment result

```
S/N1000109 S0001 OK
[
11/20/2009 15:08:19
REF/LAV/SCE T0001
10°/D65
L* 55.69
a* 60.55
b* 31.83
```

• **Print Example 2**

<Sample> detail screen: "Difference" tab

ΔL^*	0.10	Lighter
Δa^*	0.04	+Red
Δb^*	0.00	
ΔE^*_{ab}	0.11	10°/D65
		Pass

Color difference and pass/fail judgment result (and tone indication)

```
S/N1000109 S0001 OK
[
11/20/2009 15:08:19
REF/LAV/SCE T0001
10°/D65
dL* 0.10 Lighter
da* 0.04 +Red
db* 0.00
dE*ab 0.11
```

When the color assessment settings is set to ON, the tones are displayed.

• **Print Example 3**

<Sample> detail screen: "Abs. & Diff." tab

10°/D65	L*	a*	b*	
Target	55.59	60.51	31.82	
Sample	55.69	60.55	31.83	
Diff.	0.10	0.04	0.00	
ΔE^*_{ab}		0.11		
10°/C	L*	a*	b*	MI
Target	55.82	58.52	32.09	0.00
Sample	55.92	58.56	32.09	
Diff.	0.11	0.04	0.00	
ΔE^*_{ab}		0.11		Pass

Absolute value, color difference and pass/fail judgment result (colorimetric value measured with Illuminant 1 and Illuminant 2)

```
S/N1000109 S0001 OK
[
11/20/2009 15:08:19
REF/LAV/SCE T0001
10°/D65 10°/C
L* 55.69 55.92
a* 60.55 58.56
b* 31.83 32.09
dL* 0.10 0.11
da* 0.04 0.04
db* 0.00 0.00
dE*ab 0.11 0.11
MI 0.00
```

• **Print Example 4**

<Sample> detail screen: "Custom" tab

	S(D65)	T(D65)	D(D65)
L*	55.69	55.59	0.10
a*	60.55	60.51	0.04
b*	31.83	31.82	0.00
C*	68.41	68.36	0.04
h	27.73	27.74	-0.02

Absolute value, color difference and pass/fail judgment result specified for the custom screen

```

S/N1000109 S0001 OK
[
11/20/2009 15:08:19
REF/LAV/SCE T0001
S(D65) T(D65)
L* 55.69 55.59
a* 60.55 60.51
b* 31.83 31.82
C* 68.41 68.36
h 27.73 27.74
D(D65)
L* 0.10
a* 0.04
b* 0.00
C* 0.04
h -0.02
    
```

• **Print Example 5**

<Sample> detail screen: "Diff.Graph" tab

	L*	Diff.
Sample	55.69	0.10
a*	60.55	0.04
b*	31.83	0.00

Absolute value, color difference and pass/fail judgment result

```

S/N1000109 S0001 OK
[
11/20/2009 15:08:19
REF/LAV/SCE T0001
10/D65
dL* 0.10
da* 0.04
db* 0.00
    
```

• **Print Example 6**

<Sample> detail screen: "Assess.Graph" tab
(When the tone indication is set to ON)

Lightness	0.10	Lighter
Chroma	0.04	Vivid
Hue	0.02	Closer to Red

Color difference, pass/fail judgment result and tone indication

```

S/N1000109 S0001 OK
[
11/20/2009 15:08:19
REF/LAV/SCE T0001
10/D65
L 0.10 Lighter
C 0.04 Vivid
H 0.02 Red
    
```

• **Print Example 7**

<Sample> detail screen: "Ref/Tra" tab

Sample	Diff.	Wavelength
10.31	0.06	450nm
7.33	0.04	550nm
92.52	0.33	650nm

Spectral reflectance/transmittance and pass/fail judgment result

```

S/N1000109 S0001 OK
[
11/20/2009 15:08:19
REF/LAV/SCE T0001
DIFF.
360nm 12.74% 0.81%
370nm 15.56% 0.82%
380nm 12.00% 0.80%
390nm 11.26% 0.82%
400nm 10.82% 0.86%
410nm 10.81% 0.87%
420nm 11.00% 0.87%
430nm 11.02% 0.86%
440nm 10.90% 0.86%
450nm 10.31% 0.86%
460nm 9.18% 0.85%
470nm 8.21% 0.85%
480nm 7.51% 0.85%
490nm 7.13% 0.84%
500nm 6.92% 0.86%
510nm 6.85% 0.84%
520nm 6.81% 0.86%
530nm 6.80% 0.84%
540nm 6.92% 0.82%
550nm 7.33% 0.84%
560nm 8.68% 0.87%
570nm 12.21% 0.87%
580nm 22.75% 0.10%
590nm 44.22% 0.18%
600nm 65.85% 0.27%
610nm 80.58% 0.27%
620nm 87.05% 0.34%
630nm 89.98% 0.34%
640nm 91.55% 0.34%
650nm 92.52% 0.33%
660nm 93.00% 0.33%
670nm 93.10% 0.35%
680nm 92.91% 0.32%
    
```







The "*" is print in the left of the wavelength specified for "Specific Wavelength" in the spectral graph setting.

System-related Functions

Displaying the Instrument Information

Display the model name, version and serial number of the instrument.

[Operating Procedure]

1. Press the [MENU] button.
The <Configuration> screen is displayed.
2. Use the  or  and  or  buttons of the cross key to move the cursor to “System” and then press the [OK/ Edit] button.
The <System Settings> screen is displayed.
3. Use the  and  button of the cross key to move the cursor to “Info (SNo./Ver.)” and then press the [OK/ Edit] button.
The model name, version and serial number are displayed.
4. Press the [Back] button to return to the <System Settings> screen
5. Press the [Back] button twice to return to the screen displayed before you press the [MENU] button in step 1.

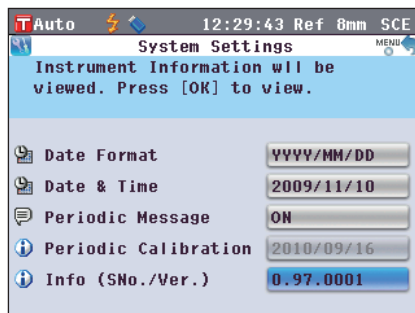
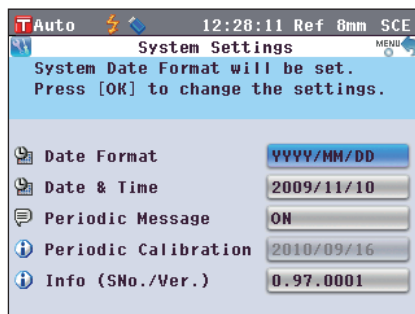
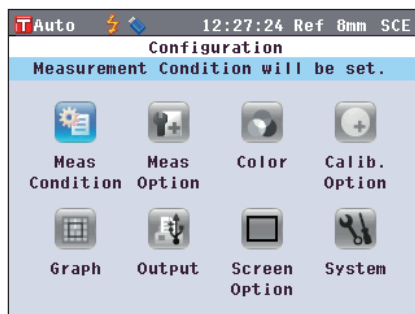

Annual Service Recalibration Recommendation Message

When about one year passes after the factory shipment or the calibration service (or maintenance) conducted by KONICA MINOLTA-authorized service facility, the CM-5 shows a message “WR050 Time for Periodic Calibration. Please contact closest Service Center.” at start-up to recommend annual service recalibration. You can set this message display to be shown, or to be hidden so that the message is not displayed even when the recommended recalibration time comes.

Notes Although the annual service recalibration recommendation message display can be hidden, it is recommended to accept our recalibration service.

Memo The message display is set to “Show” before the factory shipment.

[Operating Procedure]

1. Press the [MENU] button.

The <Configuration> screen is displayed.

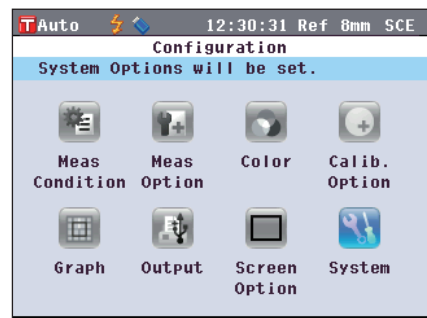

2. Use the ◀ or ▶ and ▲ or ▼ buttons of the cross key to move the cursor to “System” and then press the [OK/Edit] button.

The <System Settings> screen is displayed with “Periodic Calibration”.

Memo When the periodic calibration notification message is set to ON, the message is displayed when the specified day comes.

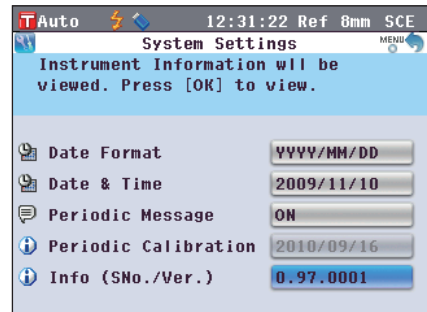

The date of the annual recalibration service is specified before the factory shipment or during KONICA MINOLTA calibration service (or maintenance) and you cannot change it.

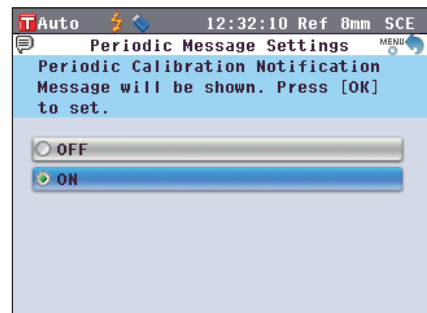

3. Use the ▲ or ▼ button of the cross key to move the cursor to “Periodic Message Settings” and then press the [OK/Edit] button.

The <Periodic Message Settings> screen is displayed.



- Use the  or  button of the cross key to move the cursor to the desired item.

Settings

- OFF: Do not show the annual service recommendation message when the specified day comes.
- ON: Show the annual service recommendation message when the specified day comes.

- Press the [OK/Edit] button.

The selection is confirmed and the screen returns to the <System Settings> screen.

Notes If you press the [Back] button without pressing the [OK/Edit] button, you return to the <System Settings> screen without changing the setting.

- Press the [Back] button twice to return to the screen displayed before you press the [MENU] button in step 1.

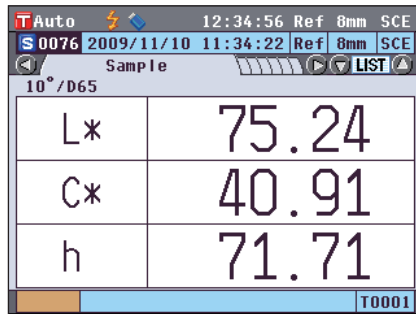
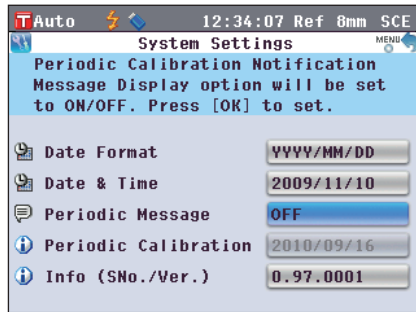
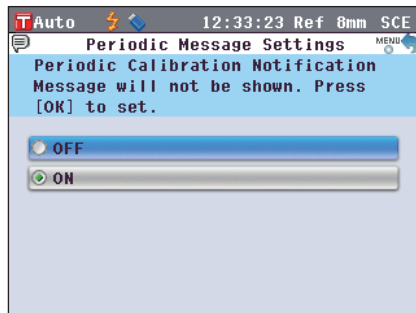

Initialization

Reset the settings of the instrument to the initial status.

- Notes**
- Do not initialize the instrument unless necessary.
 - The sample data, target color data, tolerances set to each target color and default tolerance settings will be protected and not be deleted by initialization.

Memo The sample data and target color data which you saved will be stored even after initialization. For details of the initial setting values, refer to page 156 “Initial Settings”.

[Operating Procedure]

1. Turn ON the instrument while holding down the [Target/Sample] button.

The <Initialize> screen is displayed.

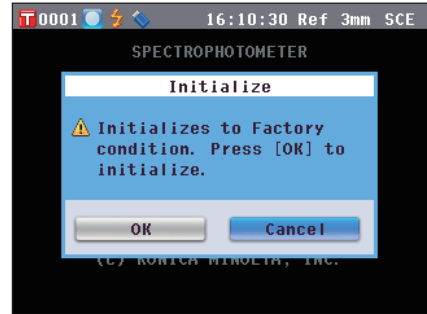

2. Use the ◀ or ▶ button of the cross key to move the cursor to “OK” and then press the [OK/Edit] button. “WR123 Please Restart Instrument.” is displayed.

Memo If you place the cursor on “Cancel” on the <Initialize> screen and press the [OK/Edit] button, the initialization is canceled and the <Sample> screen is displayed.

3. Turn OFF the instrument once and then turn it ON again. The system starts with the initialized settings.

Initial Settings

- * Initialization of the instrument will reset the settings to the initial values shown in the table below. The sample data, target color data and the tolerances set for each target color are protected and not cleared by the initialization.
- * The zero calibration data will be reset to the factory-set data. If you performed zero calibration due to a change in the measurement environment, you will need to perform zero calibration again after the initialization.
- * In certain cases, the instrument is initialized due to another cause other than the initialization operation (e.g. when the built-in backup battery life expired). In this case, the sample data, target color data and tolerance settings will also be reset to the initial status (no sample data, no target color data, default tolerance settings).

Item		Initial setting	
Zero Calibration/0% Calibration		Completed (factory-set value)	
White Calibration/100% Calibration		Not performed	
User Calibration		Not performed	
Measurement condition	Measurement Type	Reflectance measurement (Ref)	
	Measurement Area	ø30 mm	
	SCI/SCE	SCE	
Measurement option	Auto Measurement	No. of measurements: 1	
	Manual Measurement	No. of measurements: 1	
	Shutter Open/Close	Close	
Color condition	Color Space	L*a*b*	
	Difference Formula Settings	ΔE*ab	
	Color Index	None	
	Observer	10°	
	Illuminant 1	D65	
	Illuminant 2	None	
Calibration option	Auto White Calibration	ON	
	Calibration Data	White Calibration	
Graph	Custom screen	Display	ON
		Line item	L*,a*,b*,C*,h
		Column item	Sample data, target color, and color difference measured with illuminant 1
	Color Assessment		OFF
	Spectral graph	Spectral data display	ON
		Selected wavelength	450 nm, 550 nm, 650 nm
Output	Serial printer	Auto Print	OFF
		Baud Rate	9600 bps
	USB memory	File Format	CSV1
Screen option	Wizard Screen		ON
	LCD Brightness		3 (Standard)
	Display language		English
System	Date Format		MM/DD/YYYY
	Periodic Message		ON

		Item	Initial setting	
Tolerance * These are the factory-set values. Initialization of the instrument will not reset the settings to these initial values.	Color Space	ΔL^* , Δa^* , Δb^* , ΔC^* , ΔH^*	Upper limit	+1.5, ON
			Lower limit	-1.5, ON
		ΔL , Δa , Δb , ΔX , ΔY , ΔZ	Upper limit	+1.5, OFF
			Lower limit	-1.5, OFF
		Δx , Δy	Upper limit	+0.100, OFF
			Lower limit	-0.100, OFF
	Difference Formula Settings	ΔE_{00} , ΔE_{hunter} , CMC, ΔE^*_{94}	Upper limit	+1.5, OFF
		ΔE^*_{ab}	Upper limit	+1.5, ON
	Color Index	ΔWI (ASTM E313-73) , ΔWI (ASTM E313-96) , ΔWI (Hunter), ΔYI (ASTM E313-73) , ΔYI (ASTM E313-96) , ΔYI (ASTM D1925) , ΔWB (ASTM E313-73) , ΔISO Brightness	Upper limit	+1.5, OFF
			Lower limit	-1.5, OFF
	Data Protect			OFF
Auto Target			OFF	

Chapter 5

Troubleshooting

Error Messages

The following messages may appear while you are using the instrument. If such messages appear, take the necessary actions shown in the table below. If the trouble does not go away in spite of taking the actions, contact a KONICA MINOLTA-authorized service facility.

Notes The table below shows messages that may be displayed on the LCD of the instrument. For communication error check codes, refer to the separate document.

Message	Symptom/Possible Cause	Corrective Action
Preparing to auto select target color	(When Auto Target is set to ON) <ul style="list-style-type: none"> Instrument is preparing auto target color settings. 	Wait for a moment. *This message will appear when the “Auto Target” function is set to ON or when power switch is turned ON with auto target set to ON. When preparations are completed, this message will disappear.
ER005 Error in Flashing.	Xenon lamp does not flash properly. <ul style="list-style-type: none"> Xenon lamp has blown. Faulty flash circuit. Faulty sensor 	If this message keeps appearing, contact a KONICA MINOLTA-authorized service facility.
ER007 Clock Error	Clock IC is not working correctly. <ul style="list-style-type: none"> Since power voltage of backup battery is exhausted due to instrument not being used for a long time, data of calendar or clock has been lost. Internal backup battery has reached the end of its life. Breakdown of circuits relating to the clock IC. 	Set date and time after charging the internal backup battery. If this message keeps appearing, the battery has reached the end of its life. Contact a KONICA MINOLTA-authorized service facility.
ER037 USER CALIBRATION DATA NOT SET	Data for performing white calibration or user calibration has not been input in the instrument’s memory.	To input user calibration data to the instrument, you need to connect the instrument with a computer and use the optional software. For details of the procedure, read the software manual. You cannot input the calibration data of the built-in White Calibration Plate to the instrument. For details, contact a KONICA MINOLTA-authorized service facility.
ER011 Calibration was not performed correctly.	Zero calibration (0% calibration) or white calibration (100% calibration) has not been performed correctly.	Read page 52 “Zero calibration (0% Calibration)” or page 55 “White Calibration (100% Calibration)” and perform the calibration properly such as by using the optional Zero Calibration Box.
	Target Mask is not correct.	Attach the correct Target Mask.
ER013 A/D Conversion Error.	Failed during A/D conversion. <ul style="list-style-type: none"> Faulty A/D converter Breakdown of circuits relating to the A/D converter 	Turn the power OFF, and then turn it ON again. If this message keeps appearing, contact a KONICA MINOLTA-authorized service facility.

Message	Symptom/Possible Cause	Corrective Action
ER024 White Calibration has not been performed	White calibration (100% calibration) has not been completed.	The instrument requires white calibration (100% calibration) for specified measurement conditions when it is turned ON for the first time. (It is also recommended that white calibration (100% calibration) be performed whenever the instrument is turned ON or when the ambient environment changes.) White calibration (100% calibration) may also be required when the measurement area, specular component mode or other measurement conditions are changed.
ER025 Lens Error	<ul style="list-style-type: none"> Faulty drive motor Breakdown of drive circuit Faulty drive sensor 	Confirm the measurement area, and then try the measurement again. If this message keeps appearing, contact a KONICA MINOLTA-authorized service facility.
ER026 Shutter Error	<ul style="list-style-type: none"> Faulty drive motor Breakdown of drive circuit Faulty drive sensor 	Confirm the shutter behavior, and then try the measurement again. If this message keeps appearing, contact a KONICA MINOLTA-authorized service facility.
ER027 Charge Circuit is not ready.	Charging for flashing of xenon lamp is not completed. <ul style="list-style-type: none"> Breakdown of charging circuit 	Confirm that  (Ready to measure) is displayed and then perform measurement. If this message keeps appearing, contact a KONICA MINOLTA-authorized service facility.
ER031 Light Trap Error	<ul style="list-style-type: none"> Faulty drive motor Breakdown of drive circuit Faulty drive sensor 	Confirm the switching operation between SCI and SCE, and then try the measurement again. If this message keeps appearing, contact a KONICA MINOLTA-authorized service facility.
ER036 User Calibration has not been performed.	User calibration has not been performed.	When user calibration is to be performed instead of white calibration (100% calibration), the instrument requires user calibration for specified measurement conditions when it is turned ON for the first time. (It is also recommended that user calibration be performed whenever the instrument is turned ON or when the ambient environment changes.) User calibration may also be required when the measurement area, specular component mode or other measurement conditions are changed.
ER047 Measurement error	Measured reflectance or transmittance values are abnormal.	Perform zero calibration and white/100% calibration again according to the proper procedure, and then re-measure. If message continues to appear, contact a KONICA MINOLTA-authorized service facility.
ER069 Data Protect is ON.	Target color data which you attempted to overwrite or delete is protected.	If it is necessary to overwrite or delete the protected target data, change the data protect setting of the data to OFF.
ER083 USB memory stick not connected	The USB memory is not connected properly.	Connect the USB memory properly and securely.
	The USB memory cannot be accessed due to security function.	Disable the security function or use a USB memory without security function.
	The file was not saved in appropriate file format.	A condition file must be created with the optional software. For the procedure, refer to the software manual.
ER091 More than 31 data are selected.	Too many data are selected.	Select only up to 31 data.

Message	Symptom/Possible Cause	Corrective Action
ER092 Data with different properties selected. Calculations not possible.	The selected data have different properties (measurement type, measurement area, SCI/SCE setting, linked target).	Select only data having the same properties (measurement type, measurement area, SCI/SCE setting, linked target).
WR002 Low Illumination.	Amount of light from the xenon lamp has dropped to 50% of its initial level. <ul style="list-style-type: none"> • Deterioration of xenon lamp • Dirt on integrating sphere 	Clean the integrating sphere as explained in “Cleaning Parts” on page 17. If the problem still remains, contact a KONICA MINOLTA-authorized service facility.
WR050 Time for Periodic Calibration. Please contact closest Service Center.	Since a certain period of time has passed since the instrument was last calibrated, recalibration is recommended.	For recalibration service, contact a KONICA MINOLTA-authorized service facility. This message display can be set to be hidden. For the setting procedure, refer to page 153 “Annual Service Recalibration Recommendation Message”.
WR112 User calibration data not set	It is necessary to input data for user calibration to the instrument before setting calibration data to user calibration data.	To perform user calibration, you need to input the user calibration data to the instrument’s memory by connecting the instrument with computer and using the optional software before setting calibration data to user calibration data. For details of the procedure, read the software manual.
WR121 CALIBRATION RECOMMENDED	White calibration (100% calibration) or user calibration has not been performed yet after the power was switched on.	In order to ensure the reliability of white calibration (100% calibration), it is recommended to perform white calibration (100% calibration) or user calibration every time the instrument is turned ON or the measuring environment has changed.
WR123 Please Restart Instrument.	It is necessary to restart the instrument. <ul style="list-style-type: none"> • Memory error or incorrect clock • Executing initialization 	Turn the power OFF, and then turn it ON again.
WR051 Please set the observer to 2° and illuminant to D65.	Munsell (D65) is selected as the color space and the observer is not set to 2° and/or Illuminant1 is not set to D65.	Set observer to 2° and Illuminant1 to D65.
WR052 Please set the observer to 2° and illuminant to C.	Munsell (C) is selected as the color space and the observer is not set to 2° and/or Illuminant1 is not set to C.	Set observer to 2° and Illuminant1 to C.
WR124 System in Communication Mode. Keypad locked	The instrument is connected to a computer and in communication mode, and an instrument key was pressed.	The instrument keyboard cannot be operated while the instrument is connected to a computer. To operate keyboard keys, disconnect the instrument from the computer.
WR125 Keypad is locked.	The key which was pressed was locked by unchecking its checkbox in the System tab of the Standalone Configuration dialog when the instrument was used with SpectraMagic NX.	Use SpectraMagic NX to unlock the key by connecting the instrument and checking its checkbox in the System tab of the Standalone Configuration.
WR138 Memory Full	The connected USB memory device has insufficient remaining available space.	Use a USB memory device with sufficient available space.

Troubleshooting

If an abnormality has occurred with the instrument, take necessary actions as given in the table below. If the instrument still does not work properly, turn the power OFF, and then turn it ON again. If the symptom remains, contact a KONICA MINOLTA-authorized service facility.

Symptom	Check Point	Action
LCD is blank.	Is the AC adapter connected?	Connect the AC adapter.
Measuring button is not effective.	Is measurement still in progress?	Wait until measurement is complete, and then press the button.
	Is a screen where measurement is possible displayed?	Measuring button must be pressed while a screen that allows measurement (e.g. Calibration, Target, or Sample screen) is shown.
Abnormal measurement result	Is the specimen placed properly?	Make sure that the specimen is securely placed in the instrument to prevent leakage of light.
	Is proper calibration data used?	To perform user calibration or Petri Dish measurement, you need to input appropriate calibration data to the instrument by using the optional software. Check that the calibration plate is correct for the input calibration data before performing white calibration (100% calibration) or user calibration.
	Was white calibration (100% calibration) performed correctly?	
Was zero calibration (0% calibration) performed correctly?	Read page 52 “Zero calibration (0% Calibration)” and perform the calibration properly such as by using the optional Zero Calibration Box.	
Measurement results fluctuate.	Is the instrument and specimen kept stationary during measurement?	Do not allow the instrument and specimen to move during measurement.
Not possible to input data to computer. No commands from computer are accepted. Commands cannot be accepted correctly.	Is the USB cable connected correctly?	Connect the instrument’s USB connecting terminal to the computer’s USB port with the USB cable supplied with the instrument.
	Is the USB cable supplied with the instrument used?	
Files cannot be saved from the instrument to a USB memory. Files cannot be read from a USB memory to the instrument.	Is the USB memory connected properly? Is  (USB memory connected) shown on the LCD?	Connect the USB memory to the USB connection terminal of the instrument properly and securely. If the problem continues, turn OFF the instrument once and turn it ON again, and then connect the USB memory.
Not possible to print.	Is the printer cable connected properly?	Connect the RS-232C connector of the instrument and the connector of the printer with the optional connecting cable or the cable conforming to the requirements shown in the connection diagram on page 146.

Symptom	Check Point	Action
<p>Measurement data or settings are not held in memory, and disappear immediately.</p>	<p>The instrument's backup battery may be low immediately after purchase or following a period of prolonged non-use. Turn the instrument ON to charge the backup battery. Under this condition, the battery can be fully charged in 72 hours.</p>	<p>The backup battery has an expected service life of approximately ten years. If you find that the instrument fails to retain data in memory even after the battery has been fully charged, however, then it is likely that your battery has reached the end of its life and requires replacement. Note that you cannot replace the battery yourself. For information, please contact a KONICA MINOLTA-authorized service facility.</p>

Chapter 6

Appendix

Principles of Measurement

Illuminating/Viewing System

<Objective color reflectance measurement>

This instrument utilizes the $d_i:8^\circ/d_e:8^\circ$ geometry conforming to CIE No. 15, ASTM E1164, DIN 5033 Teil 7, ISO 7724/1 and JIS Z 8722-1982 (diffused illumination, 8-degree viewing angle) standards, and offers measurement with automatic SCI (specular component included; total reflectance) and SCE (specular component excluded; diffuse reflectance) switching.

The flow of measurement is shown below.

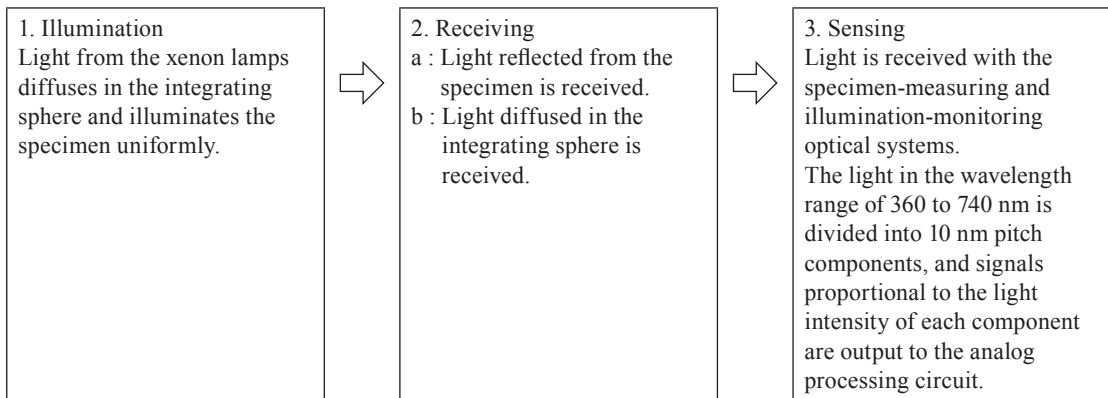

1. Light from the pulsed xenon lamp diffuses on the inner surface of the integrating sphere and illuminates the specimen uniformly.
2. a : The light reflected from the specimen surface at an angle of 8° to the normal of the surface is received by the specimen-measuring optical system.
b : The light diffused in the integrating sphere is received by the illumination-monitoring optical system and guided to the sensor.
3. The light reflected from the specimen surface and the diffused light are divided into each wavelength component by the specimen-measuring optical system and illumination-monitoring optical sensor respectively, and then signals proportional to the light intensity of each component are output to the analog processing circuit.

By processing the outputs from the specimen-measuring optical system and the illumination-monitoring sensor with the calculation by the CPU, the instrument compensates for slight fluctuations in the spectral characteristics and intensity of the illumination light. (Double-beam system)

<Object color transmittance measurement>

This instrument utilizes the $d_i:0^\circ/d_e:0^\circ$ geometry conforming to CIE No. 15, ASTM E1164 and DIN 5033 Teil 7 standards, and offers measurement with SCI (specular component included) and SCE (specular component excluded) switching.

The flow of measurement is shown below.

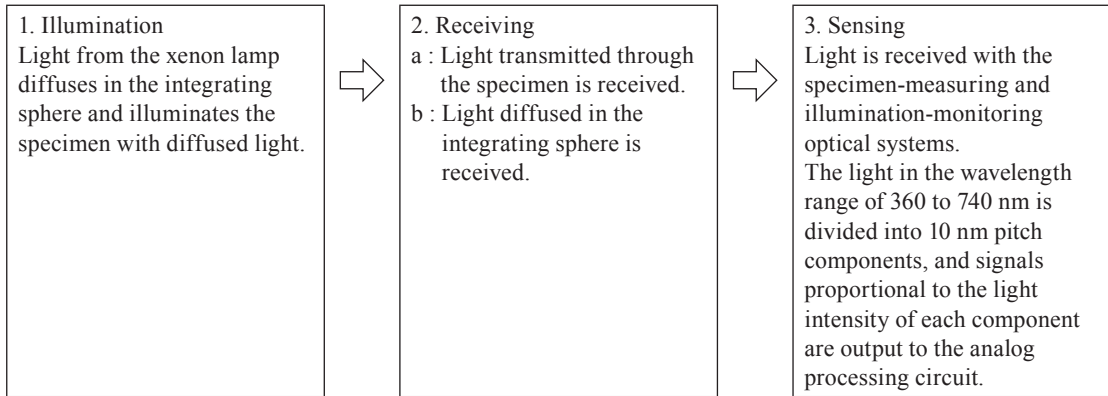

- 1 Light from the pulsed xenon lamp diffuses on the inner surface of the integrating sphere and the built-in White Calibration Plate inside the specimen measuring port shutter and illuminates the specimen placed in the Transmittance Specimen Chamber with diffused light.
- 2 a : The light transmits through the specimen is received by the specimen-measuring optical system.
b : The light diffused in the integrating sphere is received by the illumination-monitoring optical system and guided to the sensor.
- 3 The light transmitted through the specimen and the diffused light are divided into each wavelength component by the specimen-measuring optical system and illumination-monitoring optical sensor respectively, and then signals proportional to the light intensity of each component are output to the analog processing circuit.

By processing the outputs from the specimen-measuring optical system and the illumination-monitoring sensor with the calculation by the CPU, the instrument compensates for slight fluctuations in the spectral characteristics and intensity of the illumination light. (Double-beam system)

Illumination Area and Measurement Area

This instrument allows the user to select from three types of measurement area: LAV ($\phi 30$ mm), MAV ($\phi 8$ mm) and (SAV) $\phi 3$ mm, depending on the specimen and application. Attach the target mask (illumination area) to match the measurement area.

Target Mask (Illumination Area)

The instrument does not detect whether the currently attached target mask is for LAV, MAV, or SAV. Attach a target mask to match the selected measurement area.

As the condition of the edge of the target mask affects measurement, do not touch the edge of the target mask's specimen measuring port by hand, scratch it or make it dirty.

Measurement Area

The measurement area is switched by adjusting settings on the <Measurement Area Settings> screen to operate the viewing system condenser lens, which is motor controlled.

Main Specifications

Model		Spectrophotometer CM-5
Illumination/ viewing system	Reflectance:	di:8°, de:8° (diffuse illumination: 8° viewing) SCI (specular component included)/SCE (specular component excluded) switchable Conforms to CIE No. 15, ISO 7724/1, ASTM E 1164, DIN 5033 Teil 7, and JIS Z 8722 condition c standard.
	Transmittance:	di:0°, de:0° (diffuse illumination: 0° viewing) Conforms to CIE No. 15, ASTM E 1164, DIN 5033 Teil 7, and JIS Z 8722 condition g standard.
Integrating sphere size		ø152 mm
Detector		Dual 40-element silicon photodiode arrays
Spectral separation device		Planar diffraction grating
Wavelength range		360 nm to 740 nm
Wavelength pitch		10 nm
Half bandwidth		Approx. 10 nm
Measurement range		0 to 175 % (Reflectance or transmittance); Output/display resolution: 0.01%
Light source		Pulsed xenon lamp
Measurement time		Approx. 1 s (to data display/output); Minimum measurement interval: Approx. 3 s
Measurement/ Illumination area	Reflectance:	Changeable by changing mask and settings. LAV: ø30 mm/ø36 mm; MAV (optional): ø8 mm/ø11 mm; SAV (optional): ø3 mm/ø6 mm
	Transmittance:	Approx. ø20 mm/ ø26 mm
Repeatability		Spectral reflectance: Standard deviation within 0.1% (400 nm to 740 nm) Chromaticity value: Standard deviation within ΔE^*ab 0.04 (When a white calibration plate is measured 30 times at 10-second intervals after white calibration)
Inter-instrument agreement		Within ΔE^*ab 0.15 (Typical) (LAV/SCI) (Based on 12 BCRA Series II color tiles compared to values measured with a master body under Konica Minolta standard conditions)
Transmittance chamber		No sides (unlimited sample length); Depth (maximum sample thickness): 60 mm Sample holders (optional) for holding sheet samples or containers of liquid samples can be installed/removed
Display		5.7-inch TFT color LCD
Display languages		English, Japanese, German, French, Italian, Spanish, Simplified Chinese, Portuguese
White/100% calibration		Automatic white (reflectance)/100% (transmittance) calibration using internal white calibration plate (Not applicable to 100% calibration when using cells for transmittance measurements of liquids.)
Interfaces		USB 1.1 (Connection to PC, USB memory ^{*1} , USB keyboard ^{*2}); RS-232C standard (Connection to serial printer)
Observer		2° or 10° Standard Observer
Illuminant		A, C, D50, D65, F2, F6, F7, F8, F10, F11, F12, ID50, ID65 (simultaneous evaluation with two light sources possible)
Displayed data		Spectral values/graph (reflectance, transmittance, absorbance), colorimetric values/graph, color difference values/graph, pass/fail judgment, pseudocolor, color assessment
Colorimetric data		L*a*b*, L*C*h, Hunter Lab, Yxy, XYZ, and color difference in these spaces; Munsell
Indexes	Reflectance:	MI; WI (ASTM E313-73, ASTM E313-96, Hunter); YI (ASTM E313-73, ASTM E313-96, ASTM D1925); WB (ASTM E313-73); ISO Brightness
	Transmittance:	Gardner; Iodine Color Number; Platinum-Cobalt Color scale (Hazen/APHA); European Pharmacopoeia; US Pharmacopoeia
User index		User-defined index (Optional Data Management Software SpectraMagic™ NX required for setting user index.)

Model	Spectrophotometer CM-5
Color-difference equation	ΔE^*ab (CIE 1976), ΔE^*94 (CIE 1994), $\Delta E00$ (CIE DE2000), ΔE (Hunter), CMC (1:c)
Pass/Fail judgment	Tolerances can be set to colorimetric values (except Munsell), color-difference values, or reflectance index values
Data memory	Measurement data: 4,000 measurements; Target color data: 1,000 measurements
USB memory*1 storage	Storage of measurement data and target color data. Storage/reading of measurement condition settings
Power	AC 100 to 240 V, 50/60 Hz (using exclusive AC Adapter)
Size (W × H × D)	Slide cover closed: 385 × 192 × 261mm Slide cover open: 475 × 192 × 261 mm
Weight	Approx. 5.8 kg
Operation temperature/humidity range	13 to 33°C, relative humidity 80% or less (at 33°C) with no condensation
Storage temperature/humidity range	0 to 40°C, relative humidity 80% or less (at 35°C) with no condensation

*1 USB memory devices with no security features are supported.

*2 USB human interface device class US layout keyboards are supported.

(Operation is not guaranteed for all of the above supported USB memories and keyboards.)

Dimensions

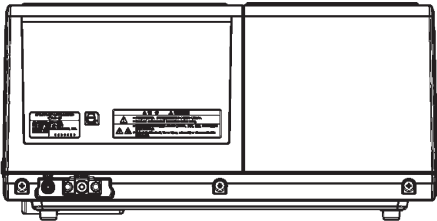
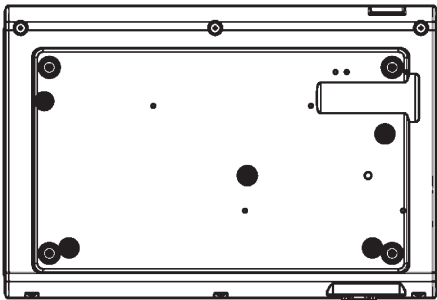
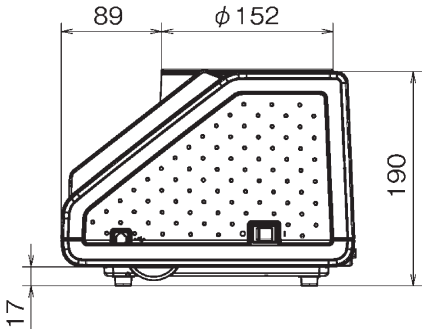
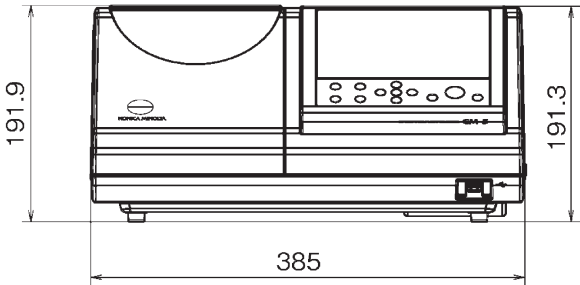
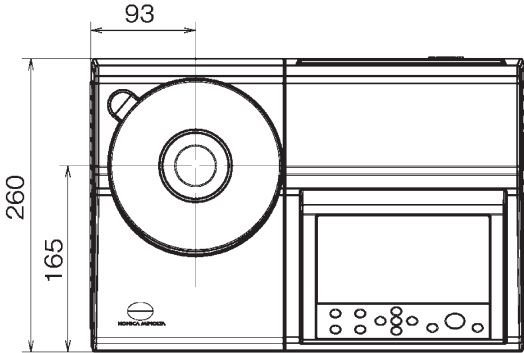

< CAUTION >

KONICA MINOLTA WILL NOT BE LIABLE FOR ANY DAMAGES RESULTING FROM THE MISUSE, MISHANDLING, UNAUTHORIZED MODIFICATION, ETC. OF THIS PRODUCT, OR FOR ANY INDIRECT OR INCIDENTAL DAMAGES (INCLUDING BUT NOT LIMITED TO LOSS OF BUSINESS PROFITS, INTERRUPTION OF BUSINESS, ETC.) DUE TO THE USE OF OR INABILITY TO USE THIS PRODUCT.



KONICA MINOLTA